

# AL1160A - AL1160AK

ATTACCHI SPECIFICI PER - SPECIFIC FITTING KIT FOR - KIT DE MONTAGE SPECIFIQUE POUR  
SPEZIFISCHER MONTAGEKIT FÜR - ANCLAJE ESPECÍFICO PARA - ANCORADOURO ESPECÍFICO

## HONDA CMX 500 REBEL (2017/2018)

N°	Descrizione	Caratteristiche	Codice	Quantità
1	Supporto - Support - Support Halteung - Soporte - Apoio	-	GNB2093DXV GNB2093SXV	2 (Dx,Sx)
2	Vite - Screw Vis - Schraube Tornillo - Parafuso	TBEI M8x40	840TBEI	2
3	Vite - Screw Vis - Schraube Tornillo - Parafuso	TBEIFN M6x16	616TBEIFN	4
4	Rondella spaccata - Split washer Scheibe - Rondelle fendue Arandela seccionada - Arruela Dentada	M8	Z1060	2
5	Rondella In Nylon - Nylon Washer Rondelle Original En Nylon - Nylonscheibe Arandela De Nylon - Arruela De Nylon	M6	Z1979	4
6	Rondella Inox - Stainless Steel Washer - Rondelle Inox Rostfreie Unterlegscheibe Aus Stahl - Arandela Inox Arruela Lisa De Aço Inox	M6	616RONX	4
7	Distanziale - Spacer Entretoise - Distanzstueck Distanciador - Espaçador	Ø16x10 Foro 8,5mm	C16L10F8,5T	2
8	Dado - Bolt - Ecrou Mutter - Tuerca - Porca	Dado Autobloccante Flangiato Ribassato M6	6DADIABFN	4
9	Particolari Inclusi Nell'100AL/100ALB Components Included In The 100AL/100ALB Pièces Inclues Dans El 100AL/100ALB Bestandteile im 100AL/100ALB enthalten Despieces Incluidos 100AL/100ALB Explodiu incluído da 100AL/100ALB	-	-	-
10	Particolari Inclusi Nell'140A/140S Components Included In The 140A/140S Pièces Inclues Dans El 140A/140S Bestandteile im 140A/140S enthalten Despieces Incluidos 140A/140S Explodiu incluído da 140A/140S	-	-	-
11	Componenti Originali - Original Parts Parties Originales - Original Bauteile Componentes Originales - Componentes Originais	-	-	-

# AL1160A - AL1160AK

ATTACCHI SPECIFICI PER - SPECIFIC FITTING KIT FOR - KIT DE MONTAGE SPECIFIQUE POUR  
SPEZIFISCHER MONTAGEKIT FÜR - ANCLAJE ESPECÍFICO PARA - ANCORADOURO ESPECÍFICO

## HONDA CMX 500 REBEL (2017/2018)

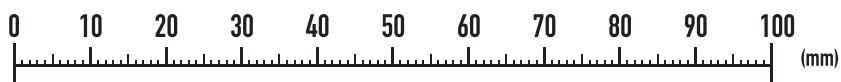
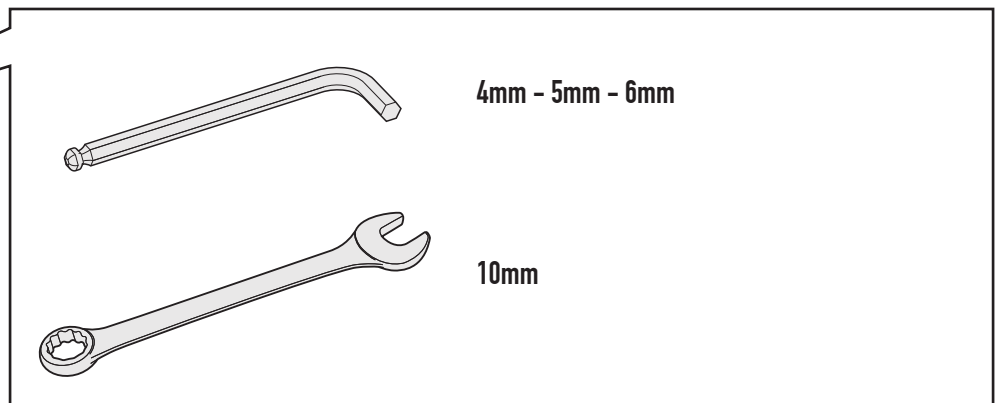
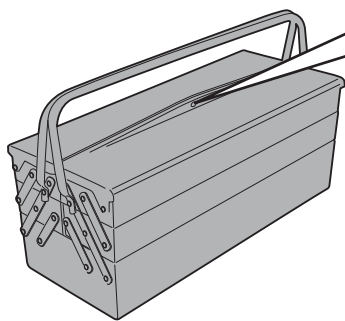
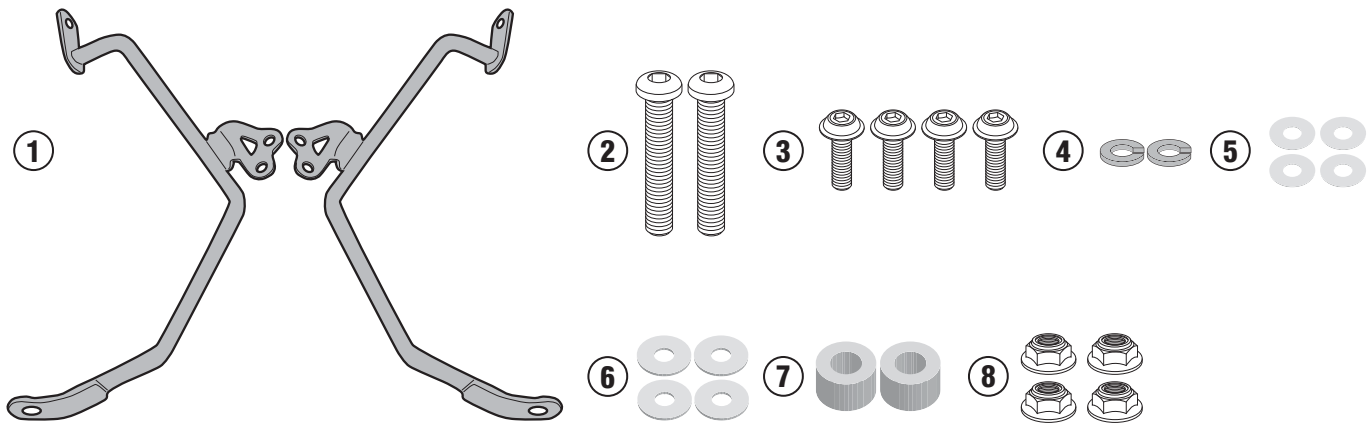



# AL1160A - AL1160A

ATTACCHI SPECIFICI PER - SPECIFIC FITTING KIT FOR - KIT DE MONTAGE SPECIFIQUE POUR  
SPEZIFISCHER MONTAGEKIT FÜR - ANCLAJE ESPECÍFICO PARA - ANCORADOURO ESPECÍFICO

## HONDA CMX 500 REBEL (2017/2018)

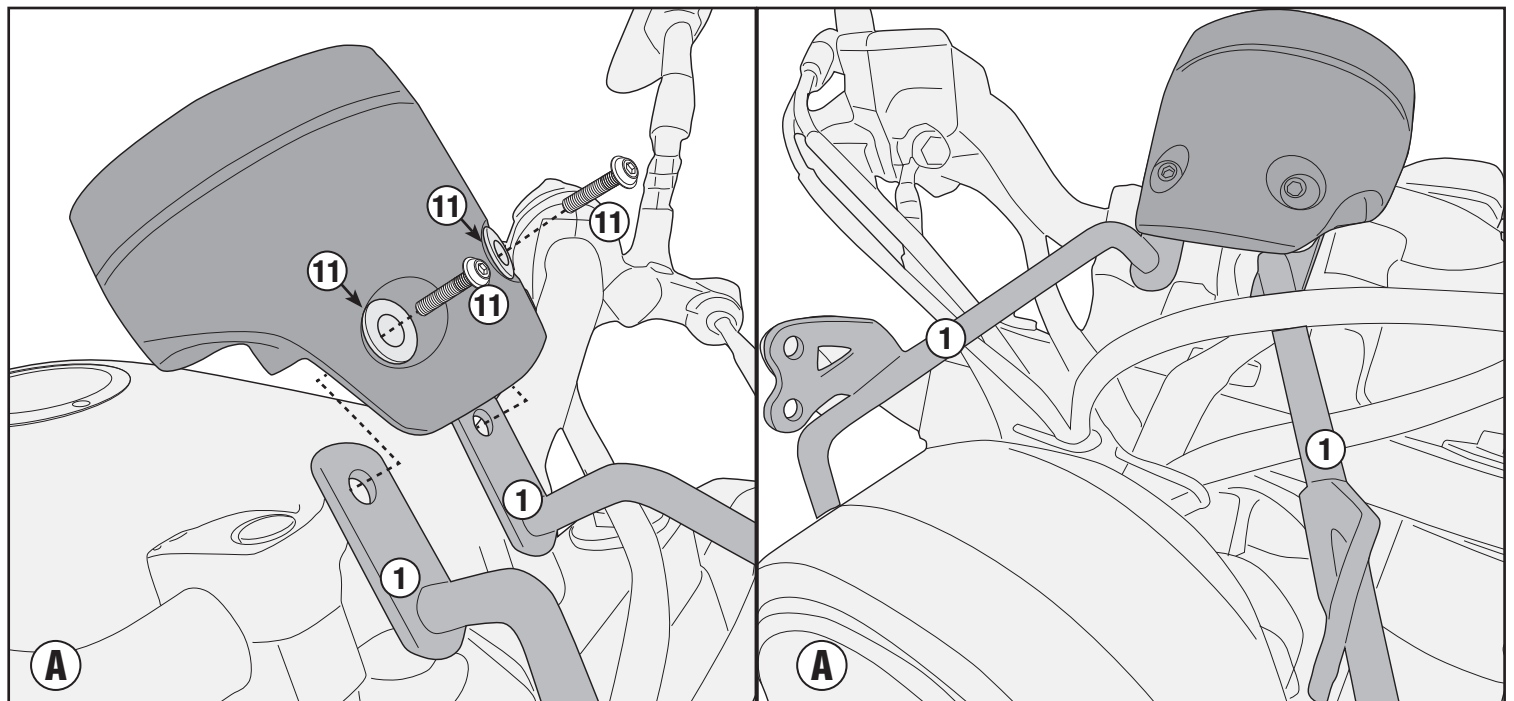
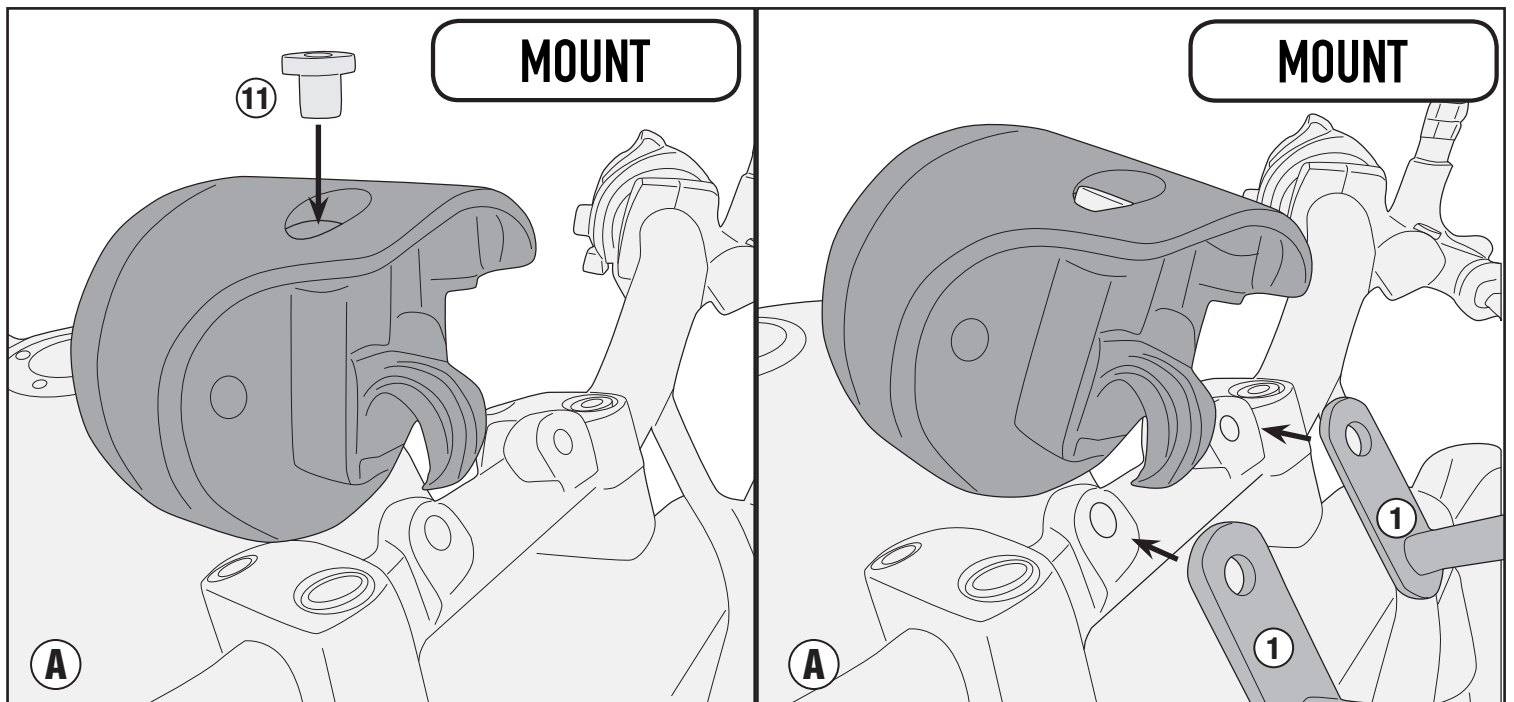

# AL1160A - AL1160AK

ATTACCHI SPECIFICI PER - SPECIFIC FITTING KIT FOR - KIT DE MONTAGE SPECIFIQUE POUR  
SPEZIFISCHER MONTAGEKIT FÜR - ANCLAJE ESPECÍFICO PARA - ANCORADOURO ESPECÍFICO

## HONDA CMX 500 REBEL (2017/2018)

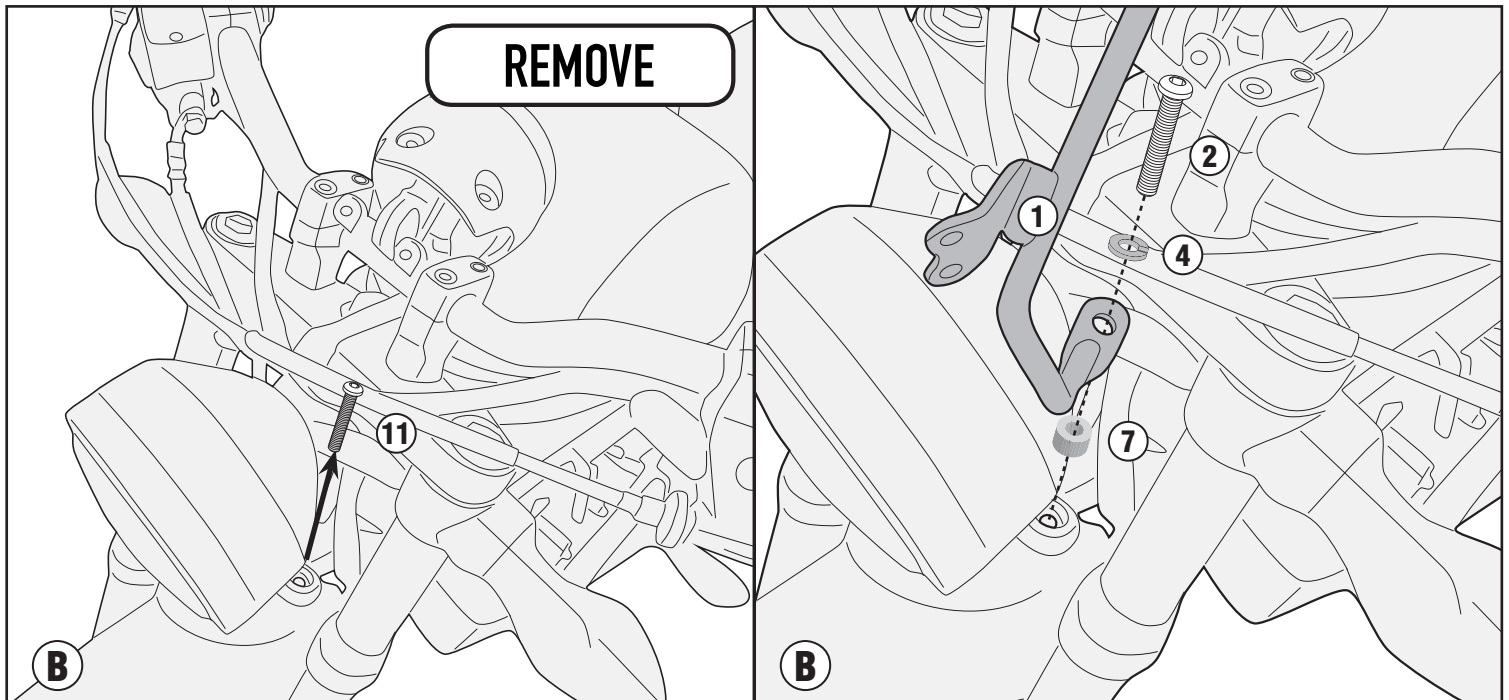

## AL1160A+100AL/100ALB

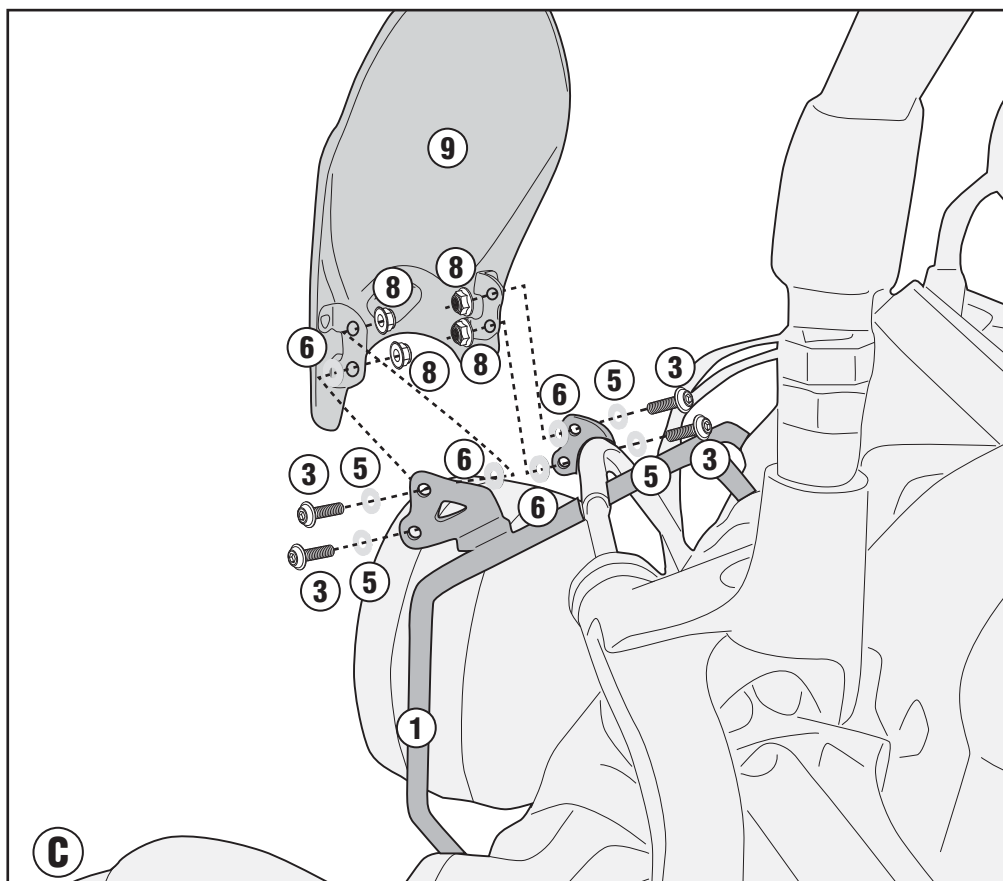

# AL1160A - AL1160AK

ATTACCHI SPECIFICI PER - SPECIFIC FITTING KIT FOR - KIT DE MONTAGE SPECIFIQUE POUR  
SPEZIFISCHER MONTAGEKIT FÜR - ANCLAJE ESPECÍFICO PARA - ANCORADOURO ESPECÍFICO

## HONDA CMX 500 REBEL (2017/2018)

### AL1160A+140A/140S

