

ANBAUANLEITUNG

mounting instructions • instructions de montage • instrucciones de montaje • istruzioni di montaggio

FBL.08.065.20000

beinhaltet • contains • contient • contiene • contiene

FBL.08.065.10000

FSC.08.065.10000

Item number: **FBL.08.065.10000**

Revision: **00** · Date: **12 - 2025**

Brake pedal

 ~ 1 h.

EASY  DIFFICULT

ENGLISH Thank you for choosing this premium product from SW-MOTECH. Visit our online shop for more information (e.g. model assignments). Required documents (e.g. national type approval) are available there for you to download.

Please read and understand all the instructions, safety information and warnings in these mounting instructions before mounting and using the product in order to avoid injury and damage. Keep these mounting instructions for reference.

This product was developed for vehicles in factory condition. Compatibility with original accessories or accessories from other manufacturers cannot be guaranteed.

These mounting instructions have been prepared to the best of our current knowledge. No legal claims relating to accuracy can be made. Errors and omissions excepted. We reserve the right to make technical and design changes. The copyright is held by SW-MOTECH.

SAFETY WARNING SYMBOL

⚠ This warning symbol is used in these mounting instructions to warn of deadly dangers, injuries or other hazards. The words DANGER, WARNING or CAUTION are used as part of this warning symbol to convey important safety messages and information relating to the installation and use of this product. These words, together with the safety warning symbol, mean:

⚠ DANGER: Indicates a hazardous situation which, if not avoided, will result in death or serious injury!

⚠ WARNING: Indicates a hazardous situation which, if not avoided, may result in death or serious injury!

⚠ CAUTION: Indicates a hazardous situation which, if not avoided, may result in minor or moderate injury!

⚠ NOTE: Important information, but not relating to a risk of death or injury (property damage only)!

GENERAL INFORMATION

⚠ WARNING: Assembly and/or maintenance of this product requires advanced technical skill, appropriate tools, and a good understanding of tool usage and torque specifications. For your own safety, SW-MOTECH recommends having the assembly and/or maintenance carried out by a qualified and certified motorcycle workshop.

⚠ WARNING: If you do choose to assemble this product yourself, carefully and fully read the mounting instructions before assembly and use, and follow all instructions to avoid serious injury or death. Also observe all relevant information in the vehicle manual when mounting or using the product. **IF YOU DO NOT UNDERSTAND ANY PART OF THESE MOUNTING INSTRUCTIONS OR NEED AN EXPLANATION AS TO A SPECIFIC INSTRUCTION, DO NOT ATTEMPT TO INSTALL THIS PRODUCT WITHOUT CONSULTING SW-MOTECH FOR ASSISTANCE!**

PREPARATION: Read the mounting instructions carefully and make sure that all parts on the parts list are available.

⚠ CAUTION: Ensure that your vehicle is standing securely. Switch off the engine and remove the ignition key. Allow the engine/exhaust to cool down if necessary. Disconnect the battery when working on the electrical system. Only use proper tools and always wear safety goggles and gloves during assembly and maintenance. Have a second person help you with assembly and maintenance.

ASSEMBLY: All parts and connections removed from the vehicle must be reinstalled according to the vehicle manufacturer's specifications or replaced with parts and hardware supplied by SW-MOTECH.

⚠ WARNING: Secure all threads with a medium-strength liquid threadlocker, unless otherwise specified.

⚠ DANGER: Tightening torques not defined by SW-MOTECH must be obtained from the vehicle manufacturer or a certified motorbike workshop.

FUNCTIONAL CHECK: After mounting the product, ensure that no moving parts are obstructed and that the function of the vehicle is not impeded. Cables and hoses must not rub against each other and/or be hindered in any way.

⚠ WARNING: Carry out a comprehensive functionality check before you start to drive. Check the tightening torque of all connections and the tight fit of the product after the first 50 km and then at regular intervals. Mounted accessories can change the handling and stability of the vehicle.



SW-MOTECH GmbH & Co. KG
Ernteweg 7-10
35282 Rauschenberg
Germany



info@sw-motech.com
www.sw-motech.com



Take note of the symbols and what they mean in the ASSEMBLY section. If the term OEM appears in the ASSEMBLY section, the vehicle manufacturer's specifications must be observed and applied.



If you have any questions, please don't hesitate to contact our Customer Service team or our distributors. You can find our telephone number and a list of our distributors in our online shop:

www.sw-motech.com



Do not use thread lock: Indicates that no liquid thread lock should be used at this point.



Tighten/note the tightening torque information:

Indicates the tightening torque of a part specified by SW-MOTECH or the vehicle manufacturer (OEM).



Use thread locker: Indicates that a thread must be coated with liquid thread locker. H (HIGH): high strength; M (MEDIUM): medium strength; L (LOW): low strength.

PARTS LIST - READ AND KEEP MOUNTING INSTRUCTIONS!

1

1



FBL.08.065.900.01.02

 **1/1**

2



FBL.00.127.003.36

 **1/1**

3



M6 x 50; DIN 912
SC.ST.06.050.01.912.088

 **1/1**

4



M6; DIN 985
MU.ST.06.01.985.08

 **1/1**

5



FBL.08.866.003.01

 **2/2**

3

6



SP.ST.020.016.01.94

 **1/1**

1



⚠ DANGER: The brake pedal is a safety-relevant component. For your safety, SW-MOTECH recommends having the installation and/or maintenance carried out by a qualified and certified specialist workshop.

⚠ WARNING: Always wear eye and hand protection!
⚠ WARNING: Always use suitable tools!

1.1: Screw the indicated parts onto the brake pedal (1).
⚠ WARNING: Use liquid thread locker (spring locating pins (5) only)!
 Do not tighten the screw (3) yet.
 Tighten the spring locating pins (5) as specified in the mounting instructions.

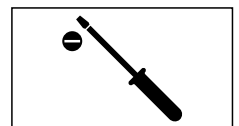
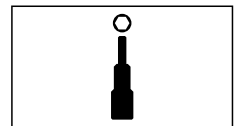
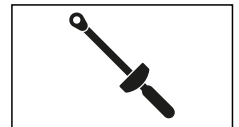
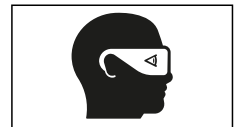

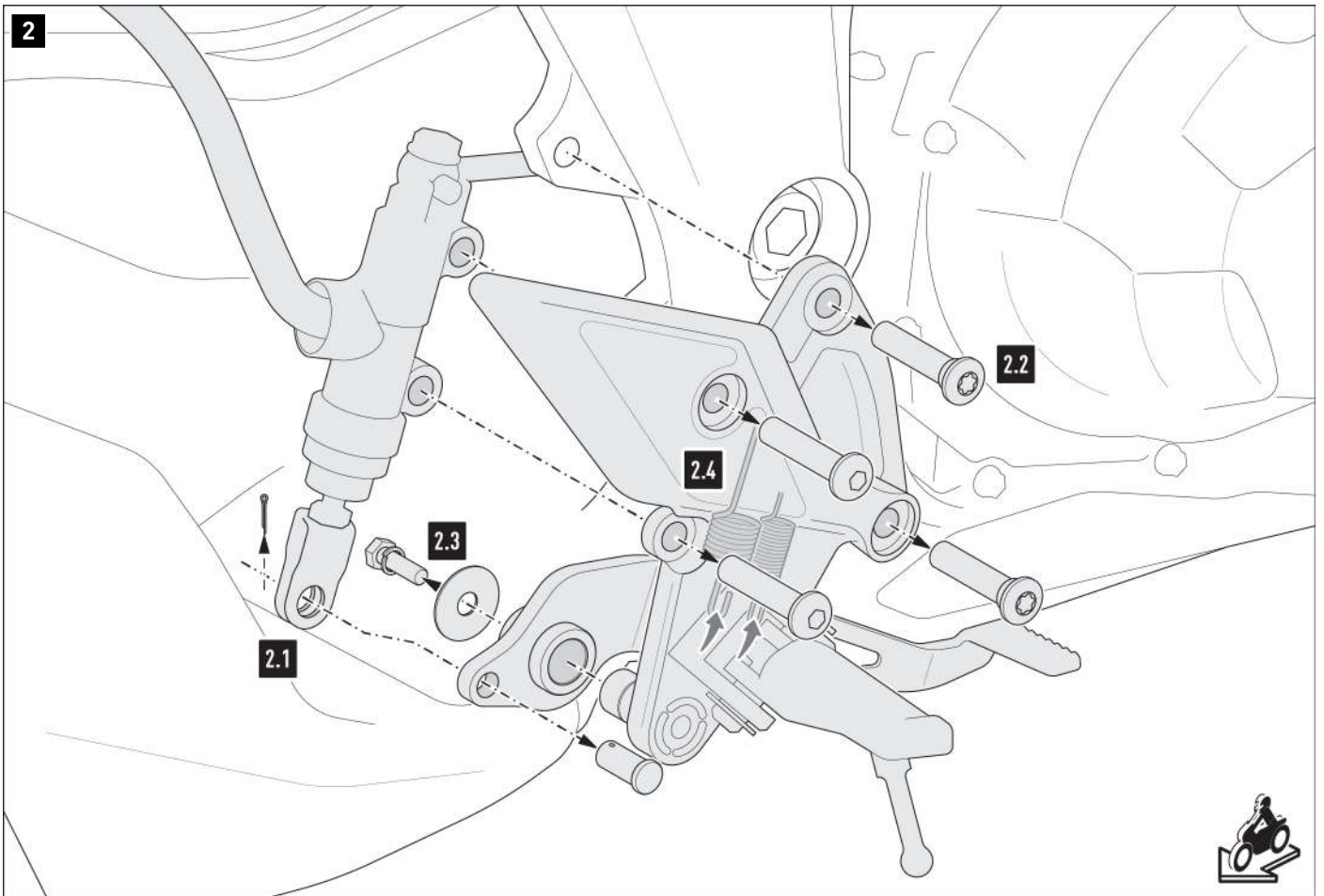

⚠ NOTE: Pay attention to the order and orientation of all original parts before removing the original brake pedal.

2.1: Remove the cotter pin and bolt from the master cylinder.

2.2: Loosen the screws on the footrest bracket as indicated.

2.3: Loosen the screw on the original brake pedal; then push the brake pedal off the mounting bolt.

2.4: Release the two springs from the original brake pedal (do **NOT** detach from the footrest bracket).

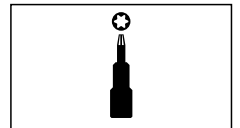
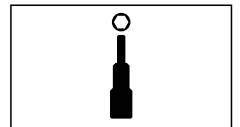

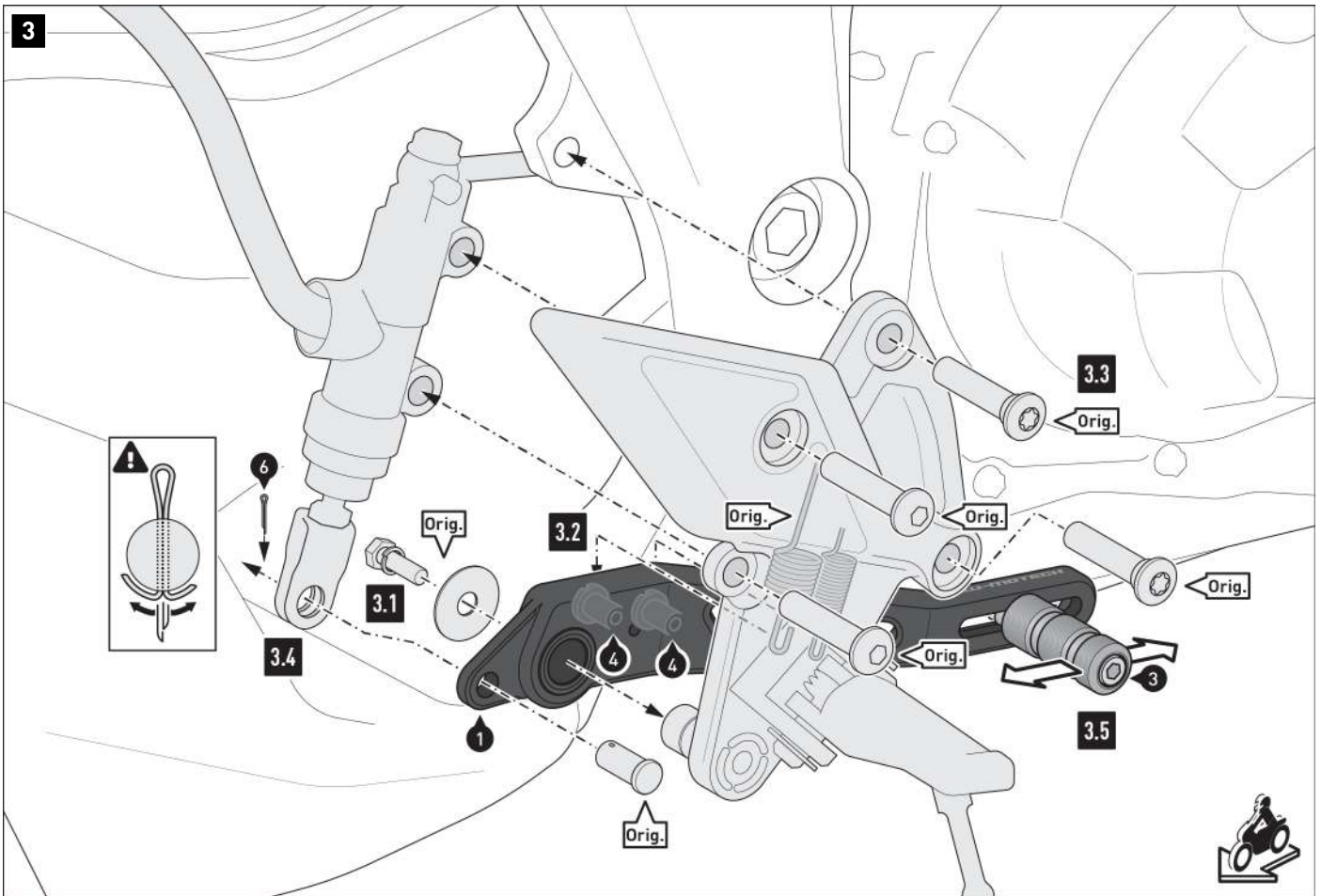

3.1: Screw the brake pedal (1) to the mounting bolt on the footrest bracket using the original parts (Orig.).

▲ WARNING: Use liquid threadlocker!

Tighten the original screw (Orig.) according to the vehicle manufacturer's specifications.

3.2: Hang the ends of the original springs (Orig.) onto the spring locating pins (5).

3.3: Screw the footrest bracket to the vehicle using the original screws (Orig.).

▲ WARNING: Use liquid threadlocker!

Tighten the original screw (Orig.) according to the vehicle manufacturer's specifications.

3.4: Attach the brake pedal (1) to the master cylinder using the original bolt and cotter pin (6).

Secure the cotter pin as illustrated in the detailed drawing.

3.5: Adjust the pedal (2) according to personal preference; then tighten the screw (3) as specified in the mounting instructions.

Double-check the functionality and position of the brake pedal (1) **BEFORE** starting your journey.

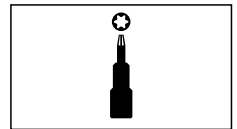
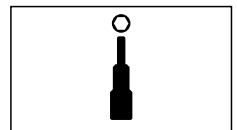
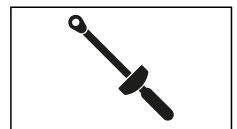

PRODUCT-SPECIFIC NOTES

⚠ DANGER: Finally, have a qualified and certified specialist workshop carry out a comprehensive functional check of the brake system of your bike.

⚠ WARNING: This product may inhibit cornering and ground clearance in cases of extreme inclination!

⚠ NOTE: Observe the country-specific regulations for registering/operating your vehicle or the applicable TÜV regulations. Have parts subject to registration entered in the vehicle documents by your inspection authority after installation.

If a national type approval is available for this product:

You must always carry the national type approval supplied with the product with you! This national type approval only applies to the models listed and must comply with all requirements! For use with a vehicle not listed here, the entry must be made in the vehicle documents!

The vehicle assignments in the national type approval document are expanded annually. As a result, the national type approval for a new product may only take place a few months after the market launch. If your model is not listed or if you no longer have the national type approval document, please visit the Download section of our web shop. The current version of the national type approval document will be available there.

Item number: **FSC.08.065.10000**

Revision: **00** · Date: **03 - 2026**

Gear lever

 ~ 0.75 h.

EASY  DIFFICULT

ENGLISH Thank you for choosing this premium product from SW-MOTECH. Visit our online shop for more information (e.g. model assignments). Required documents (e.g. national type approval) are available there for you to download.

Please read and understand all the instructions, safety information and warnings in these mounting instructions before mounting and using the product in order to avoid injury and damage. Keep these mounting instructions for reference.

This product was developed for vehicles in factory condition. Compatibility with original accessories or accessories from other manufacturers cannot be guaranteed.

These mounting instructions have been prepared to the best of our current knowledge. No legal claims relating to accuracy can be made. Errors and omissions excepted. We reserve the right to make technical and design changes. The copyright is held by SW-MOTECH.

SAFETY WARNING SYMBOL

 This warning symbol is used in these mounting instructions to warn of deadly dangers, injuries or other hazards. The words **DANGER**, **WARNING** or **CAUTION** are used as part of this warning symbol to convey important safety messages and information relating to the installation and use of this product. These words, together with the safety warning symbol, mean:

 **DANGER:** Indicates a hazardous situation which, if not avoided, will result in death or serious injury!

 **WARNING:** Indicates a hazardous situation which, if not avoided, may result in death or serious injury!

 **CAUTION:** Indicates a hazardous situation which, if not avoided, may result in minor or moderate injury!

 **NOTE:** Important information, but not relating to a risk of death or injury (property damage only)!

GENERAL INFORMATION

 **WARNING:** Assembly and/or maintenance of this product requires advanced technical skill, appropriate tools, and a good understanding of tool usage and torque specifications. For your own safety, SW-MOTECH recommends having the assembly and/or maintenance carried out by a qualified and certified motorcycle workshop.

 **WARNING:** If you do choose to assemble this product yourself, carefully and fully read the mounting instructions before assembly and use, and follow all instructions to avoid serious injury or death. Also observe all relevant information in the vehicle manual when mounting or using the product. IF YOU DO NOT UNDERSTAND ANY PART OF THESE MOUNTING INSTRUCTIONS OR NEED AN EXPLANATION AS TO A SPECIFIC INSTRUCTION, DO NOT ATTEMPT TO INSTALL THIS PRODUCT WITHOUT CONSULTING SW-MOTECH FOR ASSISTANCE!

PREPARATION: Read the mounting instructions carefully and make sure that all parts on the parts list are available.

 **CAUTION:** Ensure that your vehicle is standing securely. Switch off the engine and remove the ignition key. Allow the engine/exhaust to cool down if necessary. Disconnect the battery when working on the electrical system. Only use proper tools and always wear safety goggles and gloves during assembly and maintenance. Have a second person help you with assembly and maintenance.

ASSEMBLY: All parts and connections removed from the vehicle must be reinstalled according to the vehicle manufacturer's specifications or replaced with parts and hardware supplied by SW-MOTECH.

 **WARNING:** Secure all threads with a medium-strength liquid threadlocker, unless otherwise specified.

 **DANGER:** Tightening torques not defined by SW-MOTECH must be obtained from the vehicle manufacturer or a certified motorbike workshop.



FUNCTIONAL CHECK: After mounting the product, ensure that no moving parts are obstructed and that the function of the vehicle is not impeded. Cables and hoses must not rub against each other and/or be hindered in any way.

 **WARNING:** Carry out a comprehensive functionality check before you start to drive. Check the tightening torque of all connections and the tight fit of the product after the first 50 km and then at regular intervals. Mounted accessories can change the handling and stability of the vehicle.



SW-MOTECH GmbH & Co. KG
Ernteweg 7-10
35282 Rauschenberg
Germany



 info@sw-motech.com
 www.sw-motech.com

LEGEND OVERVIEW - READ AND KEEP MOUNTING INSTRUCTIONS!



Take note of the symbols and what they mean in the ASSEMBLY section. If the term OEM appears in the ASSEMBLY section, the vehicle manufacturer's specifications must be observed and applied.



If you have any questions, please don't hesitate to contact our Customer Service team or our distributors. You can find our telephone number and a list of our distributors in our online shop:

www.sw-motech.com



Do not use thread lock: Indicates that no liquid thread lock should be used at this point.



































Tighten/note the tightening torque information:

Indicates the tightening torque of a part specified by SW-MOTECH or the vehicle manufacturer (OEM).



Use thread locker: Indicates that a thread must be coated with liquid thread locker. H (HIGH): high strength; M (MEDIUM): medium strength; L (LOW): low strength.

PARTS LIST - READ AND KEEP MOUNTING INSTRUCTIONS!

<p>1</p> <p>1</p>  <p>FSC.08.065.900.01.02</p> <p> 1/1</p>	<p>2</p>  <p>KTM.54603069000</p> <p> 1/1</p>	<p>3</p>  <p>M6 x 25; ISO 7380 SC.ST.06.025.01.73800.109</p> <p> 1/1</p>	<p>4</p>  <p>FSC.08.368.002.35</p> <p> 1/1</p>	<p>5</p>  <p>FSC.00.127.700</p> <p> 1/1</p>	<p>6</p>  <p>M6 x 16; DIN 7991 SC.ST.06.016.01.7991.088</p> <p> 1/1</p>			
<p>7</p>  <p>M6; DIN 985 MU.ST.06.01.985.08</p> <p> 1/1</p>								
<p>4</p> <table border="1"> <tr> <td data-bbox="151 801 359 1104"> <p>8</p>  <p>FSC.00.127.011.36</p> <p> 1/1</p> </td> <td data-bbox="379 801 587 1104"> <p>9</p>  <p>M6 x 25; DIN 912 SC.ST.06.025.01.912.088</p> <p> 1/1</p> </td> <td data-bbox="608 801 815 1104"> <p>10</p>  <p>FSC.00.127.022.02</p> <p> 1/1</p> </td> </tr> </table>						<p>8</p>  <p>FSC.00.127.011.36</p> <p> 1/1</p>	<p>9</p>  <p>M6 x 25; DIN 912 SC.ST.06.025.01.912.088</p> <p> 1/1</p>	<p>10</p>  <p>FSC.00.127.022.02</p> <p> 1/1</p>
<p>8</p>  <p>FSC.00.127.011.36</p> <p> 1/1</p>	<p>9</p>  <p>M6 x 25; DIN 912 SC.ST.06.025.01.912.088</p> <p> 1/1</p>	<p>10</p>  <p>FSC.00.127.022.02</p> <p> 1/1</p>						

1

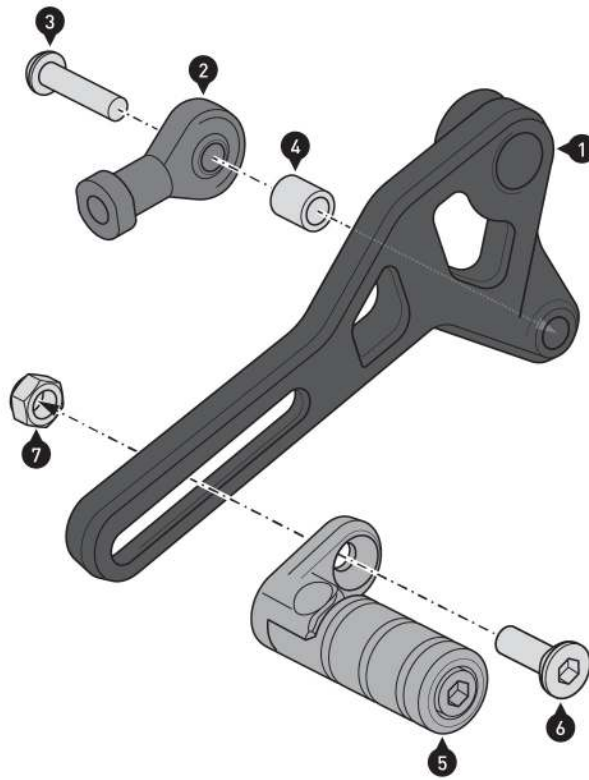

⚠ **WARNING:** Always wear eye and hand protection!
 ⚠ **WARNING:** Always use suitable tools!

⚠ **NOTE:** How to mount *optional* add-on parts (8) - (10) is outlined in **step [4]**.

Screw the indicated parts to the gear lever (1).

⚠ **WARNING:** Use liquid threadlocker (only for screw 3)!
 Tighten the screws (3) as specified in the mounting instructions.
 Do not tighten the screw (6) yet.

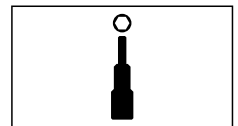
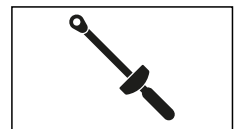
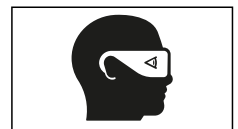

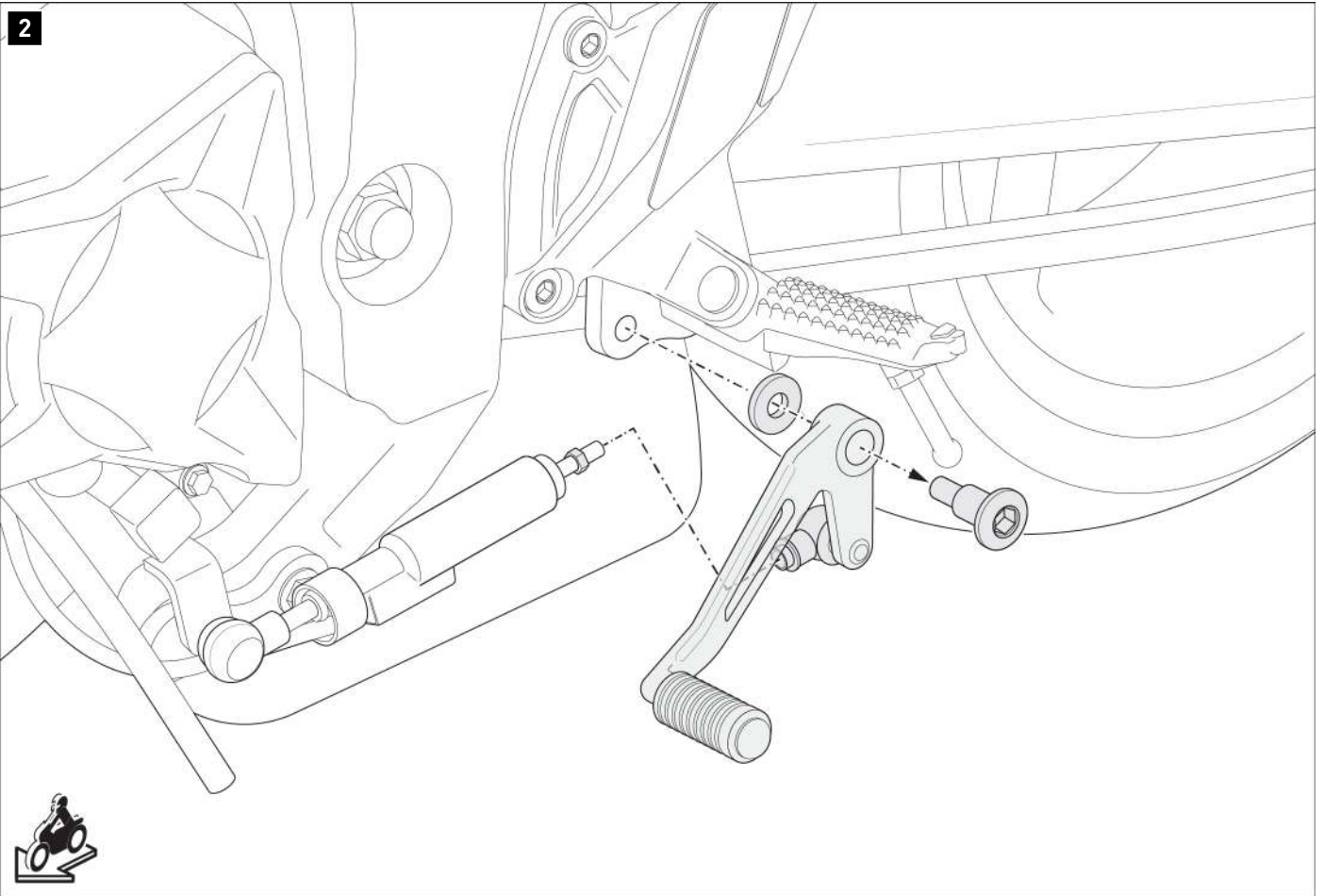

Loosen the parts indicated; remove the original gear lever from the vehicle.

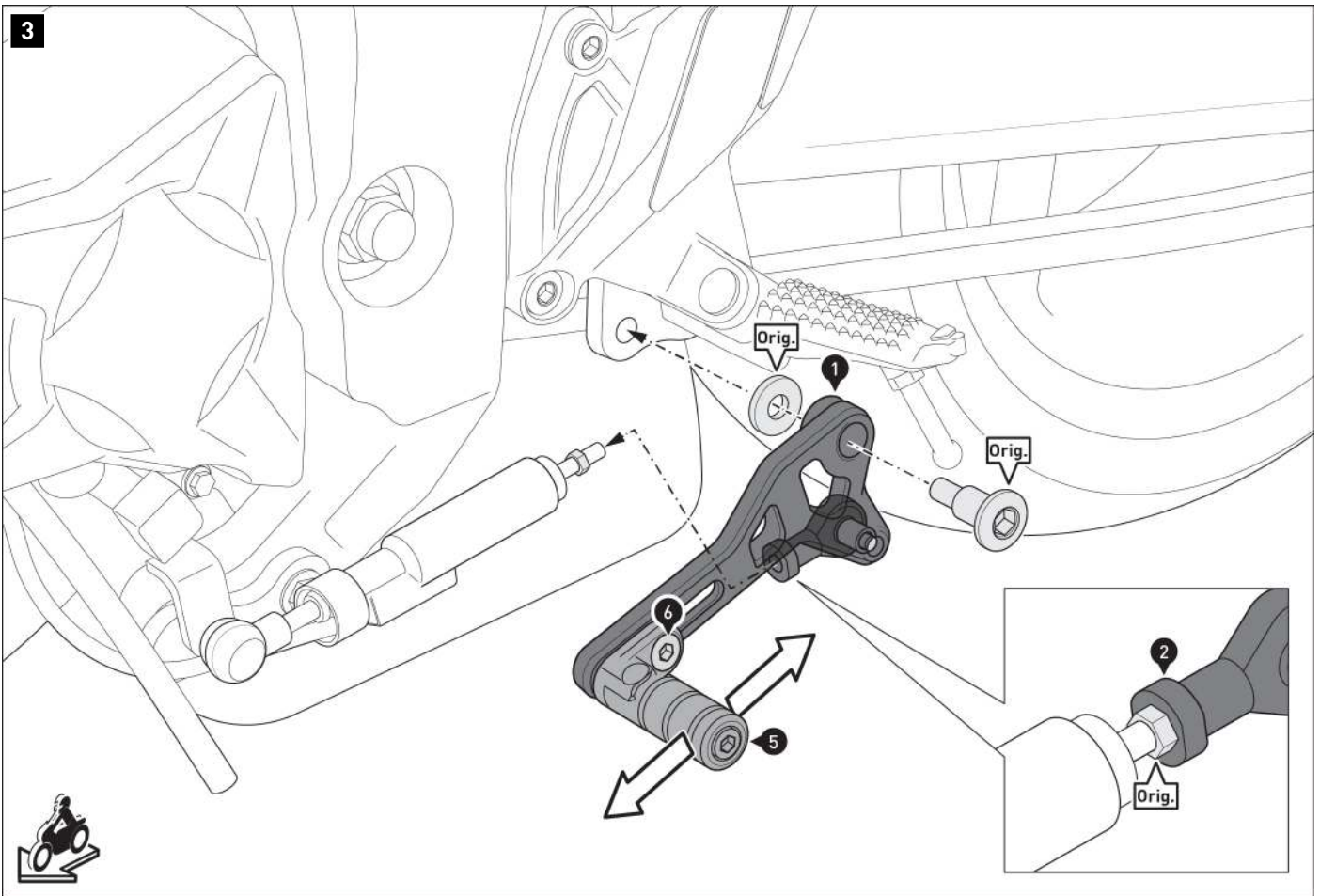

Screw the deflection rod to the ball joint (2) (min. six threads); lock the thread using the original nut (Orig.).

Screw the gear lever (1) to the footrest mount using the original screw (Orig.).

▲ WARNING: Use liquid threadlocker!

Tighten the original screw (Orig.) according to the vehicle manufacturer's specifications.

Adjust the tread (5) according to your personal riding preferences. Then tighten the screw (6) as specified in the mounting instructions.

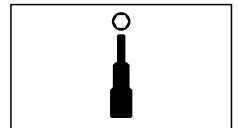
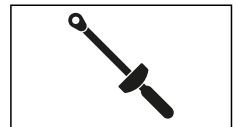

4

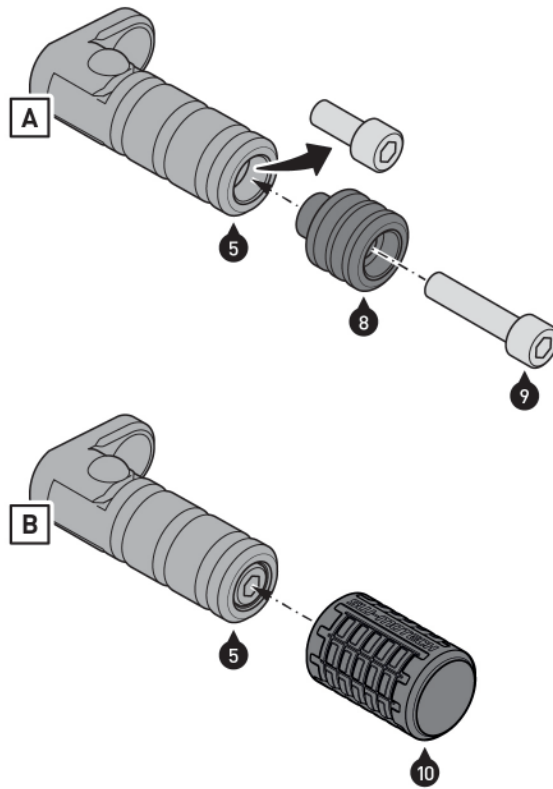

⚠ **NOTE:** This step is *optional*.

Option [A]: Remove the factory-installed screw from the (5) pedal. Screw the pedal extension (8) to the pedal (5).

⚠ **WARNING: Use liquid threadlocker!**

Tighten the screw (9) as specified in the mounting instructions.

Option [B]: Place the rubber sleeve (10) over the pedal (5).

Ensure that the inner rings of the rubber sleeve (10) are positioned in the recesses of the pedal (5).

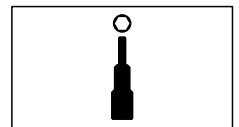
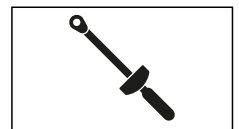

PRODUCT-SPECIFIC NOTES

⚠ WARNING: This product may limit cornering and ground clearance when riding at extreme lean angles!

⚠ WARNING: After installing the gear lever, ensure that all components in the surrounding area are uninhibited! Shift through all gears and make sure that the gear lever is properly adjusted for you as a driver!

⚠ NOTE: Please observe the country-specific regulations for the registration/operation of your vehicle or any applicable TÜV regulations. Have parts subject to registration entered in the vehicle documents by your inspection authority after installation.