

ANBAUANLEITUNG

mounting instructions • instructions de montage • instrucciones de montaje • istruzioni di montaggio

BC.HTA.41.092.30000/B

beinhaltet • contains • contient • contiene • contiene

HTA.41.092.10000

HTA.41.092.11000

BC.HTA.00.677.10000L/B

BC.HTA.00.677.10000R/B

Item number: HTA.41.092.10000

Revision: 00 · Date: 12 - 2023

SLC left side carrier

 ~ 0.5 h.EASY     DIFFICULT

ENGLISH Thank you for choosing this premium product from SW-MOTECH. Visit our online shop for more information (e.g. model assignments). Required documents (e.g. national type approval) are available there for you to download.

Please read and understand all the instructions, safety information and warnings in these mounting instructions before mounting and using the product in order to avoid injury and damage. Keep these mounting instructions for reference.

This product was developed for vehicles in factory condition. Compatibility with original accessories or accessories from other manufacturers cannot be guaranteed.

These mounting instructions have been prepared to the best of our current knowledge. No legal claims relating to accuracy can be made. Errors and omissions excepted. We reserve the right to make technical and design changes. The copyright is held by SW-MOTECH.

SAFETY WARNING SYMBOL

 This warning symbol is used in these mounting instructions to warn of deadly dangers, injuries or other hazards. The words DANGER, WARNING or CAUTION are used as part of this warning symbol to convey important safety messages and information relating to the installation and use of this product. These words, together with the safety warning symbol, mean:

 **DANGER:** Indicates a hazardous situation which, if not avoided, will result in death or serious injury!

 **WARNING:** Indicates a hazardous situation which, if not avoided, may result in death or serious injury!

 **CAUTION:** Indicates a hazardous situation which, if not avoided, may result in minor or moderate injury!

 **NOTE:** Important information, but not relating to a risk of death or injury (property damage only)!

GENERAL INFORMATION

 **WARNING:** Assembly and/or maintenance of this product requires advanced technical skill, appropriate tools, and a good understanding of tool usage and torque specifications. For your own safety, SW-MOTECH recommends having the assembly and/or maintenance carried out by a qualified and certified motorcycle workshop.

 **WARNING:** If you do choose to assemble this product yourself, carefully and fully read the mounting instructions before assembly and use, and follow all instructions to avoid serious injury or death. Also observe all relevant information in the vehicle manual when mounting or using the product. IF YOU DO NOT UNDERSTAND ANY PART OF THESE MOUNTING INSTRUCTIONS OR NEED AN EXPLANATION AS TO A SPECIFIC INSTRUCTION, DO NOT ATTEMPT TO INSTALL THIS PRODUCT WITHOUT CONSULTING SW-MOTECH FOR ASSISTANCE!

PREPARATION: Read the mounting instructions carefully and make sure that all parts on the parts list are available.

 **CAUTION:** Ensure that your vehicle is standing securely. Switch off the engine and remove the ignition key. Allow the engine/exhaust to cool down if necessary. Disconnect the battery when working on the electrical system. Only use proper tools and always wear safety goggles and gloves during assembly and maintenance. Have a second person help you with assembly and maintenance.

ASSEMBLY: All parts and connections removed from the vehicle must be reinstalled according to the vehicle manufacturer's specifications or replaced with parts and hardware supplied by SW-MOTECH.

 **WARNING:** Secure all threads with a medium-strength liquid threadlocker, unless otherwise specified.

 **DANGER:** Tightening torques not defined by SW-MOTECH must be obtained from the vehicle manufacturer or a certified motorbike workshop.

FUNCTIONAL CHECK: After mounting the product, ensure that no moving parts are obstructed and that the function of the vehicle is not impeded. Cables and hoses must not rub against each other and/or be hindered in any way.

 **WARNING:** Carry out a comprehensive functionality check before you start to drive. Check the tightening torque of all connections and the tight fit of the product after the first 50 km and then at regular intervals. Mounted accessories can change the handling and stability of the vehicle.



SW-MOTECH GmbH & Co. KG
Ernteweg 7-10
35282 Rauschenberg
Germany



info@sw-motech.com
www.sw-motech.com



Take note of the symbols and what they mean in the ASSEMBLY section. If the term OEM appears in the ASSEMBLY section, the vehicle manufacturer's specifications must be observed and applied.



If you have any questions, please don't hesitate to contact our Customer Service team or our distributors. You can find our telephone number and a list of our distributors in our online shop:

www.sw-motech.com



Use thread locker: Indicates that a thread must be coated with liquid thread locker. H (HIGH): high strength; M (MEDIUM): medium strength; L (LOW): low strength.



Tighten/note the tightening torque information:

Indicates the tightening torque of a part specified by SW-MOTECH or the vehicle manufacturer (OEM).



Do not use thread lock: Indicates that no liquid thread lock should be used at this point.

PARTS LIST - READ AND KEEP MOUNTING INSTRUCTIONS!

1

1



HTA.41.092.901.01.04

 1/1

2



HTA.00.152.080.35

 3/3

3



HTA.00.152.081.00

 1/1

4



M6 x 20; DIN 6912
SC.ST.06.020.01.6912.088

 1/1

5



M6 x 20; DIN 7991
SC.ST.06.020.48.7991.109

 2/2

4

6



M8 x 55; ISO 7380
SC.ST.08.055.02.7380.109

 2/2

7



Ø 18 / ø 8,4 / h 3
DB.ST.0180.0084.0030.02

 1/1

8



M8; DIN 6927
MU.ST.08.02.6927.08

 4/4

9



M8 x 70; ISO 7380
SC.ST.08.070.02.7380.109

 1/1

10



Ø 24 / ø 11 / h 25,3
DB.ST.240.110.253.01

 1/1

11



M8 x 20; ISO 7380
SC.ST.08.020.02.7380.109

 1/1

1

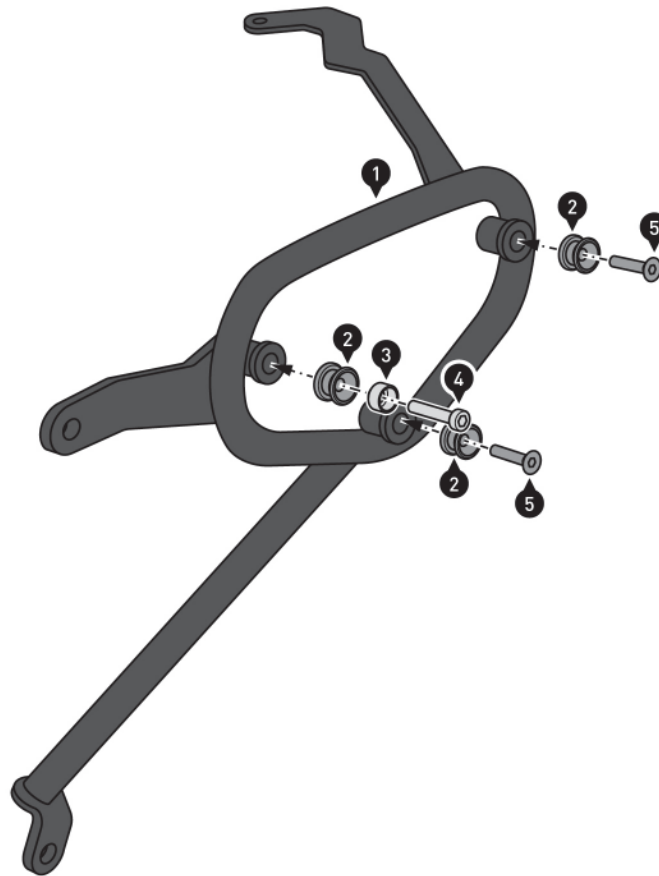

▲ WARNING: Always wear eye and hand protection!
▲ WARNING: Always use the proper tools!

Screw the parts [2] to [5] to the side carrier [1].

▲ WARNING: Use a liquid threadlocker!
 Tighten the screws as specified in the mounting instructions.

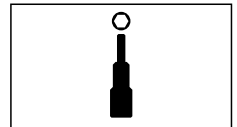
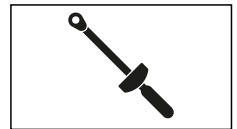
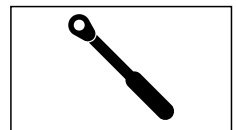
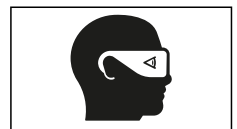
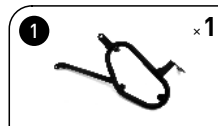

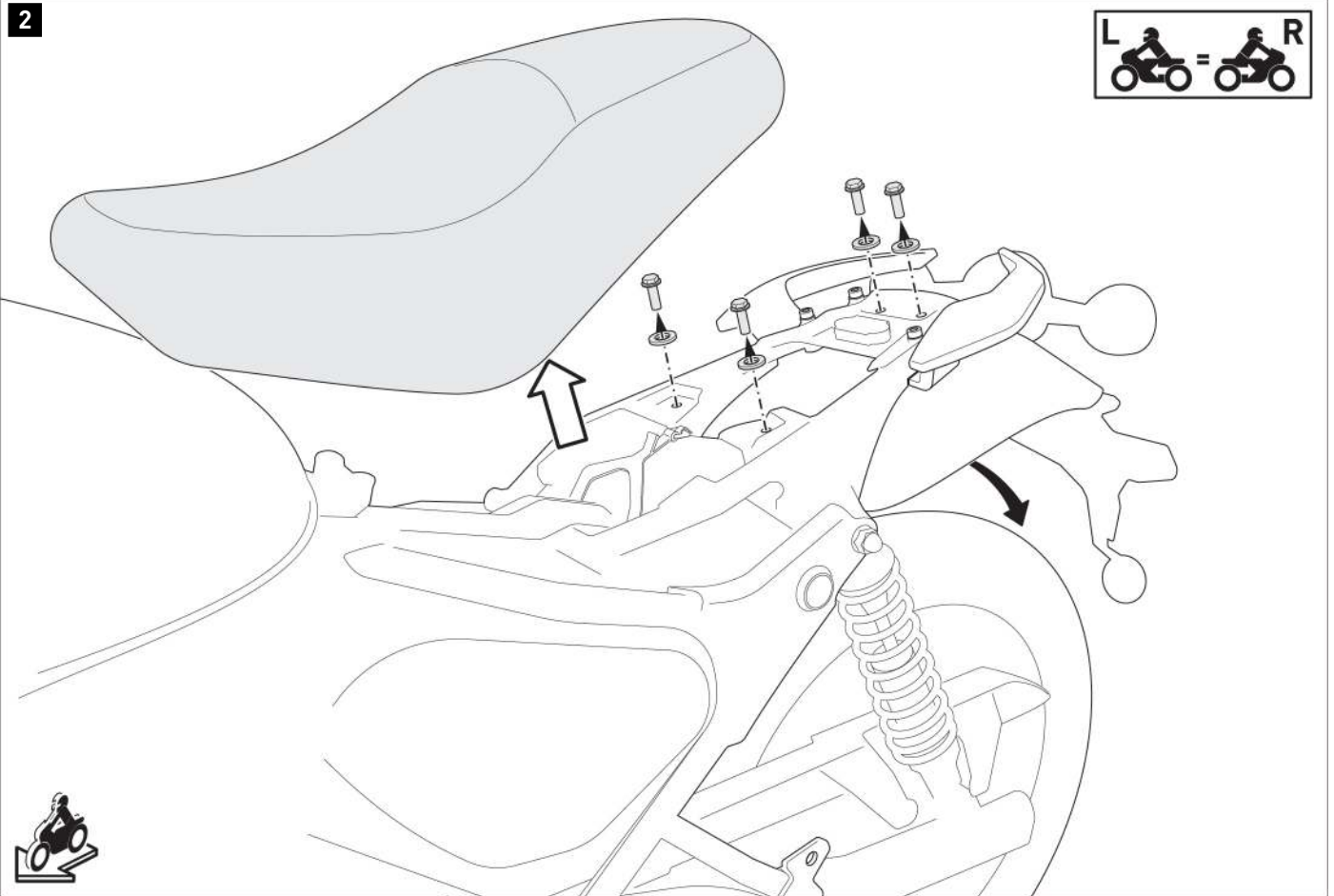

3

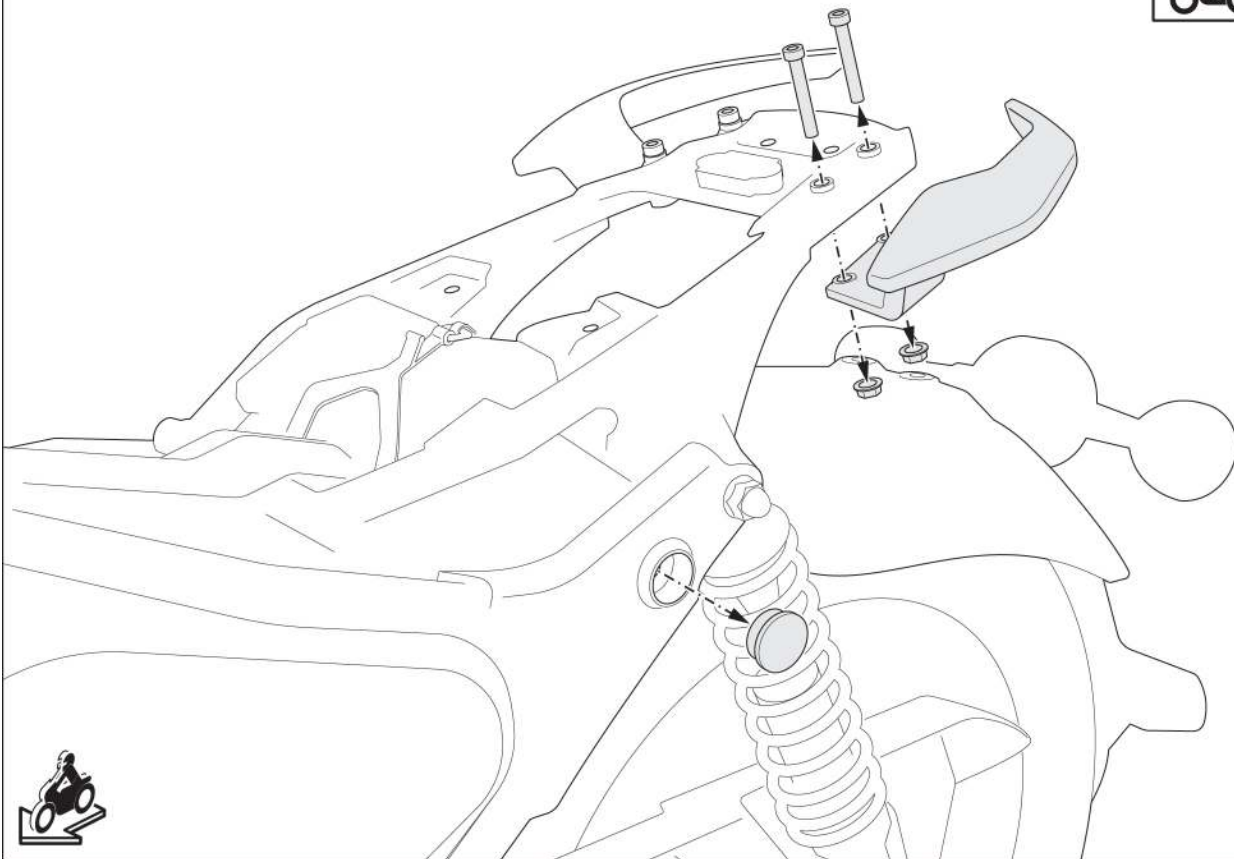

Loosen the screws, and remove the passenger handle from the vehicle.

Remove the frame cover shown.

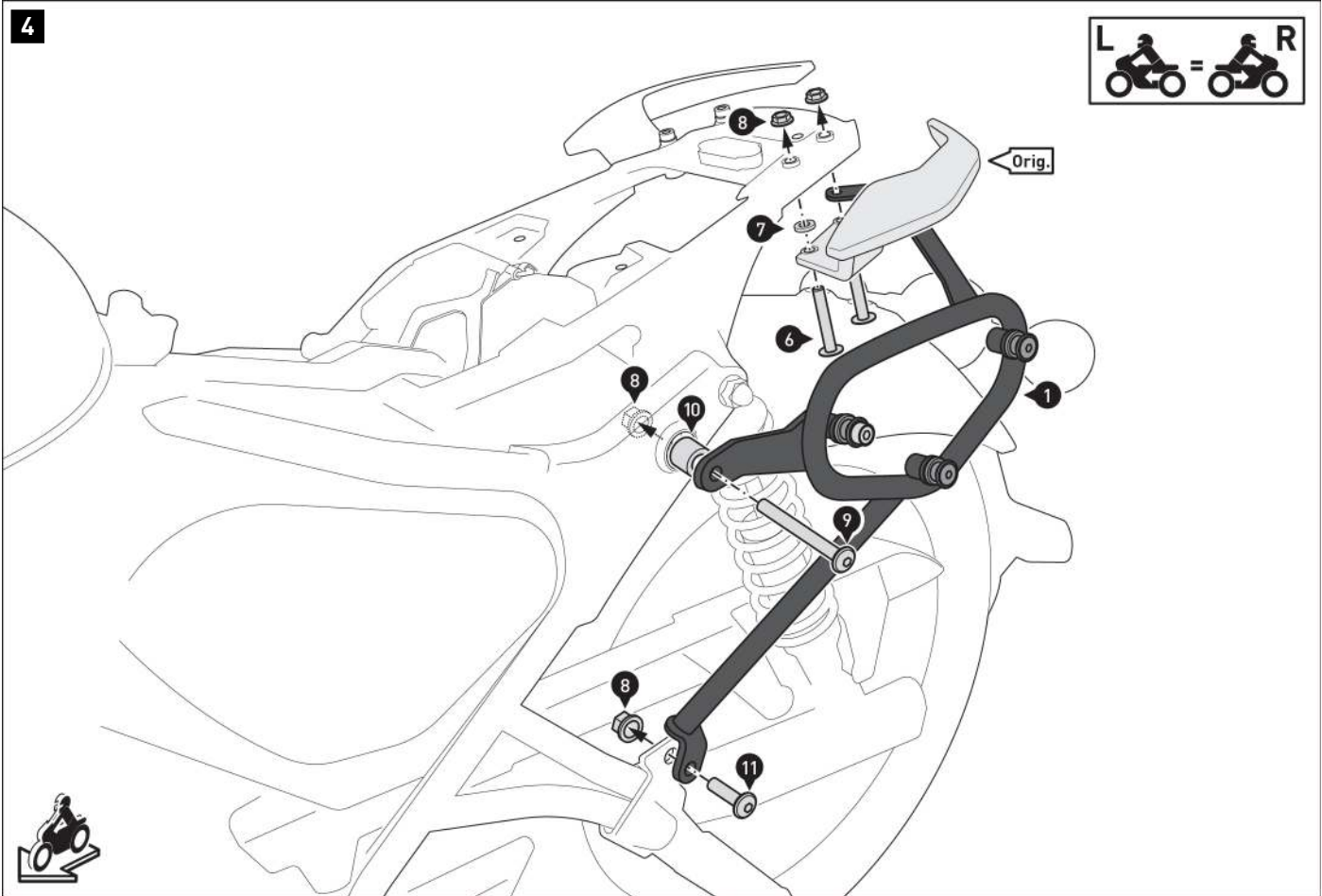

Screw the side carrier (1) to the passenger grab handle (original) on the vehicle.
Tighten the screws as specified in the mounting instructions.

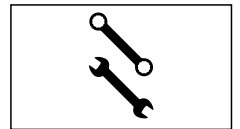
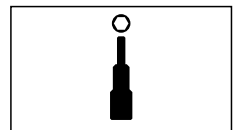
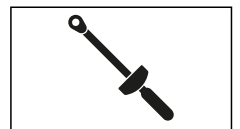

5

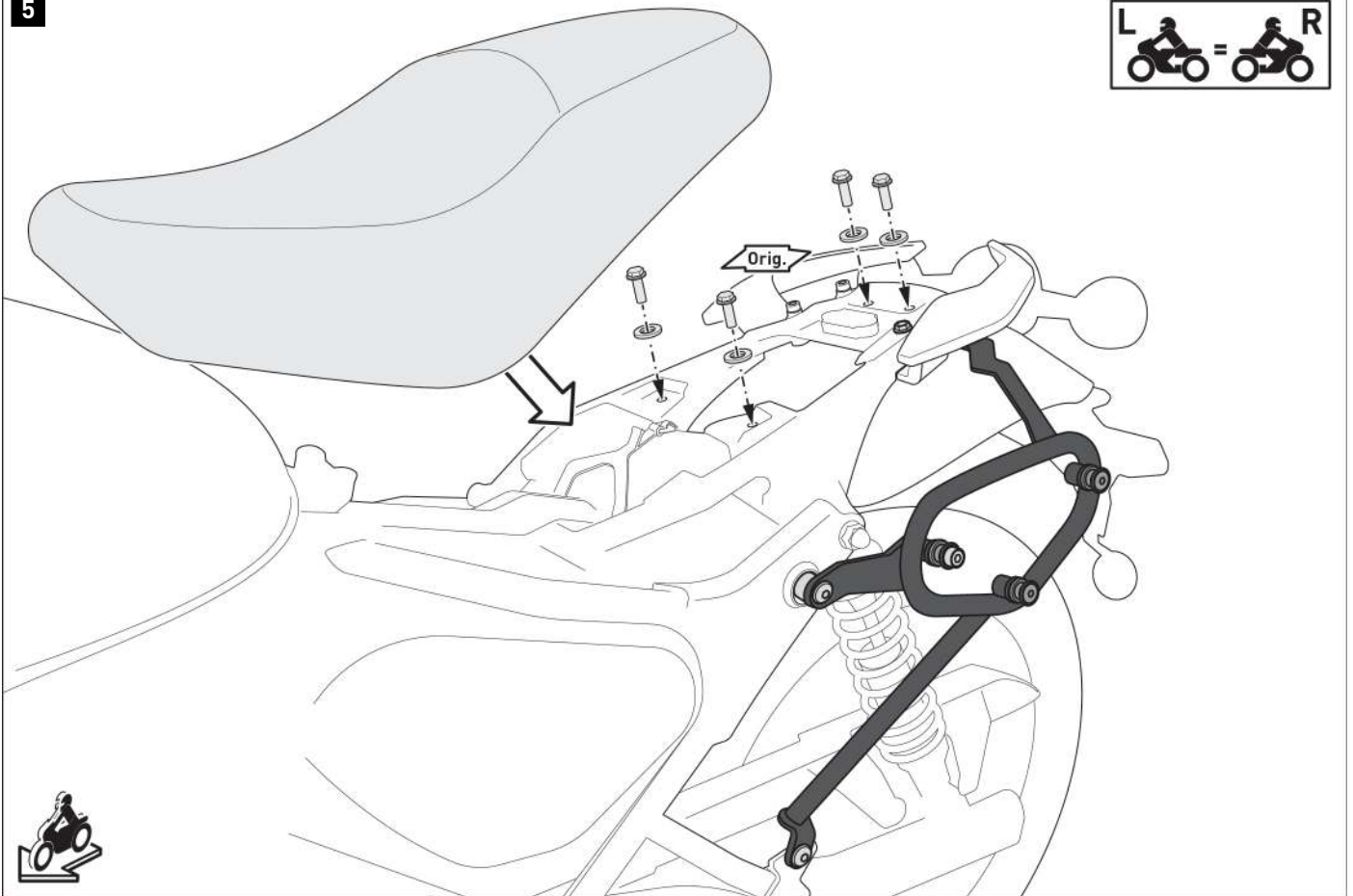

Screw the fender back onto the vehicle.
Tighten the original (Orig.) screws according to the manufacturer's instructions.

Finally, put the seat back on.

PRODUCT-SPECIFIC NOTES

⚠ NOTE: *Observe the country-specific regulations for the registration/operation of your vehicle or applicable TÜV regulations. After assembly, have parts that are subject to registration entered in the vehicle documents by your test centre.*

Item number: HTA.41.092.11000

Revision: 00 · Date: 12 - 2023

SLC side carrier right

 ~ 0.5 h.

EASY     DIFFICULT

ENGLISH Thank you for choosing this premium product from SW-MOTECH. Visit our online shop for more information (e.g. model assignments). Required documents (e.g. national type approval) are available there for you to download.

Please read and understand all the instructions, safety information and warnings in these mounting instructions before mounting and using the product in order to avoid injury and damage. Keep these mounting instructions for reference.

This product was developed for vehicles in factory condition. Compatibility with original accessories or accessories from other manufacturers cannot be guaranteed.

These mounting instructions have been prepared to the best of our current knowledge. No legal claims relating to accuracy can be made. Errors and omissions excepted. We reserve the right to make technical and design changes. The copyright is held by SW-MOTECH.

SAFETY WARNING SYMBOL

 This warning symbol is used in these mounting instructions to warn of deadly dangers, injuries or other hazards. The words **DANGER**, **WARNING** or **CAUTION** are used as part of this warning symbol to convey important safety messages and information relating to the installation and use of this product. These words, together with the safety warning symbol, mean:

 **DANGER:** Indicates a hazardous situation which, if not avoided, will result in death or serious injury!

 **WARNING:** Indicates a hazardous situation which, if not avoided, may result in death or serious injury!

 **CAUTION:** Indicates a hazardous situation which, if not avoided, may result in minor or moderate injury!

 **NOTE:** Important information, but not relating to a risk of death or injury (property damage only)!

GENERAL INFORMATION

 **WARNING:** Assembly and/or maintenance of this product requires advanced technical skill, appropriate tools, and a good understanding of tool usage and torque specifications. For your own safety, SW-MOTECH recommends having the assembly and/or maintenance carried out by a qualified and certified motorcycle workshop.

 **WARNING:** If you do choose to assemble this product yourself, carefully and fully read the mounting instructions before assembly and use, and follow all instructions to avoid serious injury or death. Also observe all relevant information in the vehicle manual when mounting or using the product. IF YOU DO NOT UNDERSTAND ANY PART OF THESE MOUNTING INSTRUCTIONS OR NEED AN EXPLANATION AS TO A SPECIFIC INSTRUCTION, DO NOT ATTEMPT TO INSTALL THIS PRODUCT WITHOUT CONSULTING SW-MOTECH FOR ASSISTANCE!

PREPARATION: Read the mounting instructions carefully and make sure that all parts on the parts list are available.

 **CAUTION:** Ensure that your vehicle is standing securely. Switch off the engine and remove the ignition key. Allow the engine/exhaust to cool down if necessary. Disconnect the battery when working on the electrical system. Only use proper tools and always wear safety goggles and gloves during assembly and maintenance. Have a second person help you with assembly and maintenance.

ASSEMBLY: All parts and connections removed from the vehicle must be reinstalled according to the vehicle manufacturer's specifications or replaced with parts and hardware supplied by SW-MOTECH.

 **WARNING:** Secure all threads with a medium-strength liquid threadlocker, unless otherwise specified.

 **DANGER:** Tightening torques not defined by SW-MOTECH must be obtained from the vehicle manufacturer or a certified motorbike workshop.

FUNCTIONAL CHECK: After mounting the product, ensure that no moving parts are obstructed and that the function of the vehicle is not impeded. Cables and hoses must not rub against each other and/or be hindered in any way.

 **WARNING:** Carry out a comprehensive functionality check before you start to drive. Check the tightening torque of all connections and the tight fit of the product after the first 50 km and then at regular intervals. Mounted accessories can change the handling and stability of the vehicle.



SW-MOTECH GmbH & Co. KG
Ernteweg 7-10
35282 Rauschenberg
Germany



info@sw-motech.com
www.sw-motech.com



Take note of the symbols and what they mean in the ASSEMBLY section. If the term OEM appears in the ASSEMBLY section, the vehicle manufacturer's specifications must be observed and applied.



If you have any questions, please don't hesitate to contact our Customer Service team or our distributors. You can find our telephone number and a list of our distributors in our online shop:

www.sw-motech.com



Use thread locker: Indicates that a thread must be coated with liquid thread locker. H (HIGH): high strength; M (MEDIUM): medium strength; L (LOW): low strength.



Tighten/note the tightening torque information:

Indicates the tightening torque of a part specified by SW-MOTECH or the vehicle manufacturer (OEM).



Do not use thread lock: Indicates that no liquid thread lock should be used at this point.

PARTS LIST - READ AND KEEP MOUNTING INSTRUCTIONS!

1

1



HTA.41.092.902.01.04

 1/1

2



HTA.00.152.080.35

 3/3

3



HTA.00.152.081.00

 1/1

4



M6 x 20; DIN 6912
SC.ST.06.020.01.6912.088

 1/1

5



M6 x 20; DIN 7991
SC.ST.06.020.48.7991.109

 2/2

4

6



M8 x 55; ISO 7380
SC.ST.08.055.02.7380.109

 2/2

7



Ø 18 / ø 8,4 / h 3
DB.ST.0180.0084.0030.02

 1/1

8



M8; DIN 6927
MU.ST.08.02.6927.08

 4/4

9



M8 x 70; ISO 7380
SC.ST.08.070.02.7380.109

 1/1

10



Ø 24 / ø 11 / h 25,3
DB.ST.240.110.253.01

 1/1

11



M8 x 20; ISO 7380
SC.ST.08.020.02.7380.109

 1/1

1

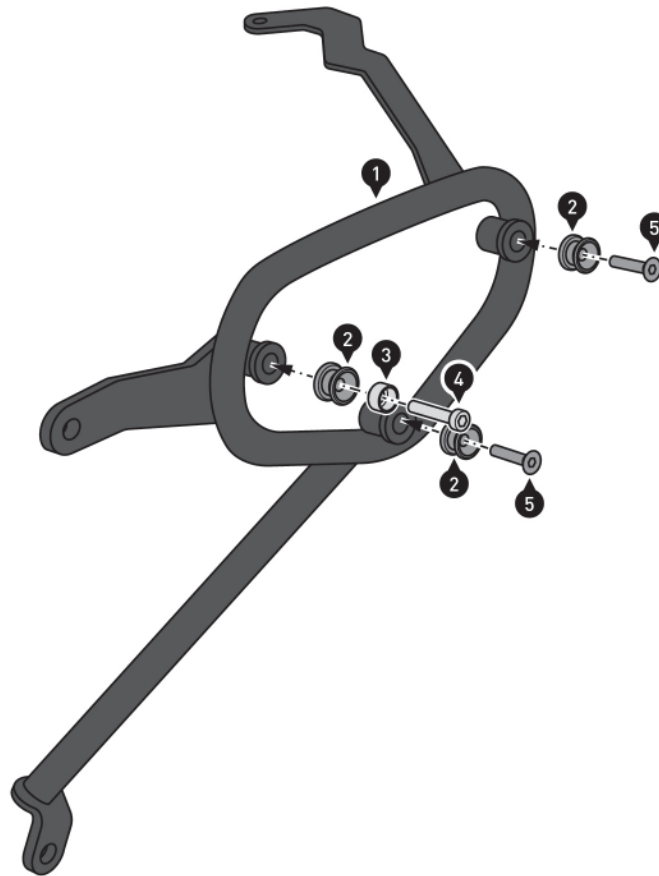

- ▲ **WARNING:** Always wear eye and hand protection!
- ▲ **WARNING:** Always use the proper tools!

Screw the parts [2] to [5] to the side carrier [1].

- ▲ **WARNING:** Use a liquid threadlocker!

Tighten the screws as specified in the mounting instructions.

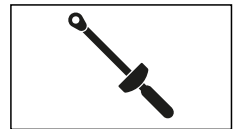
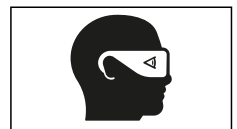
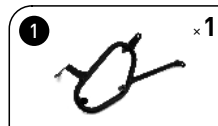

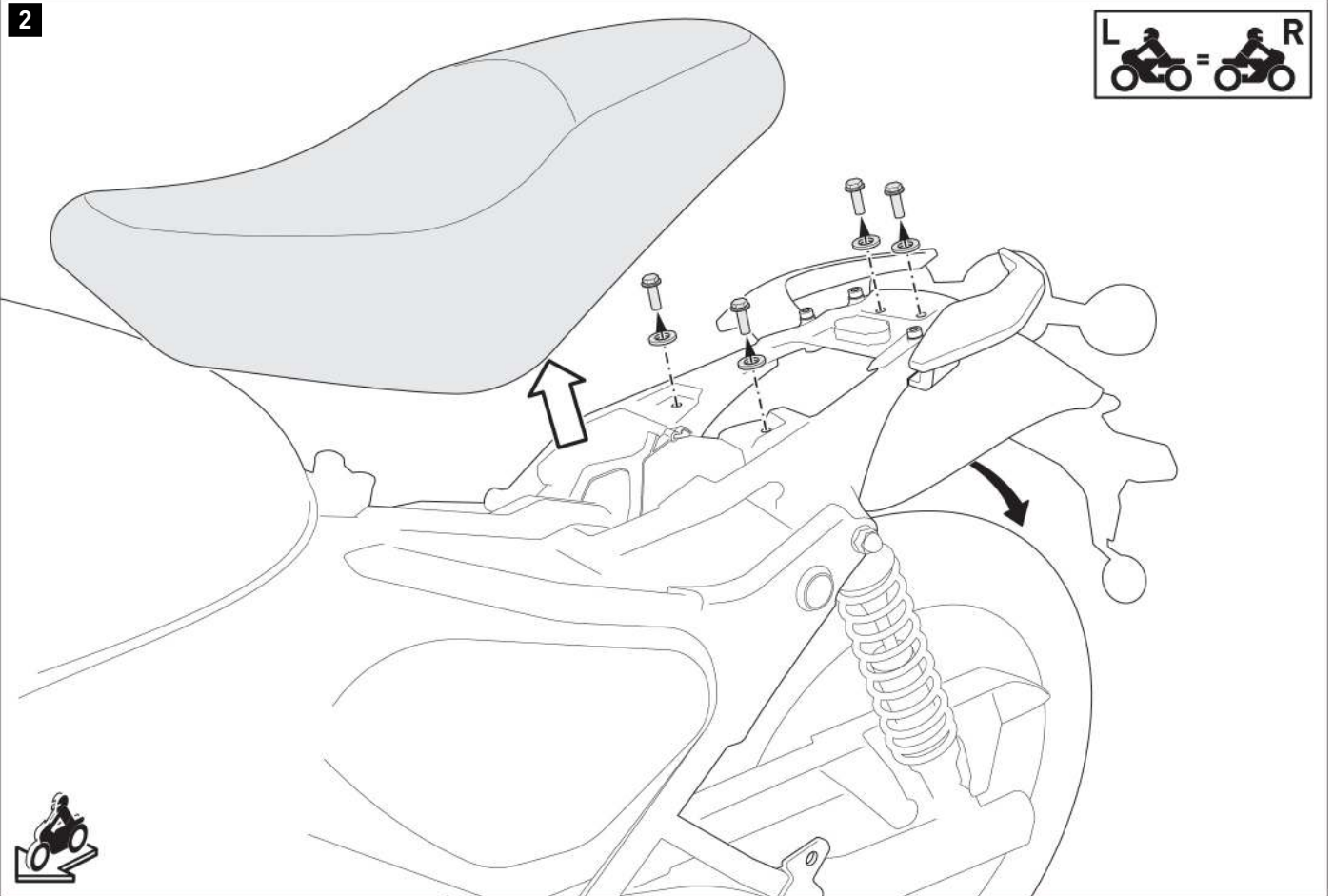

Remove the seat from the vehicle.

Remove the screws shown from the vehicle, and place the fender on the rear wheel.

3

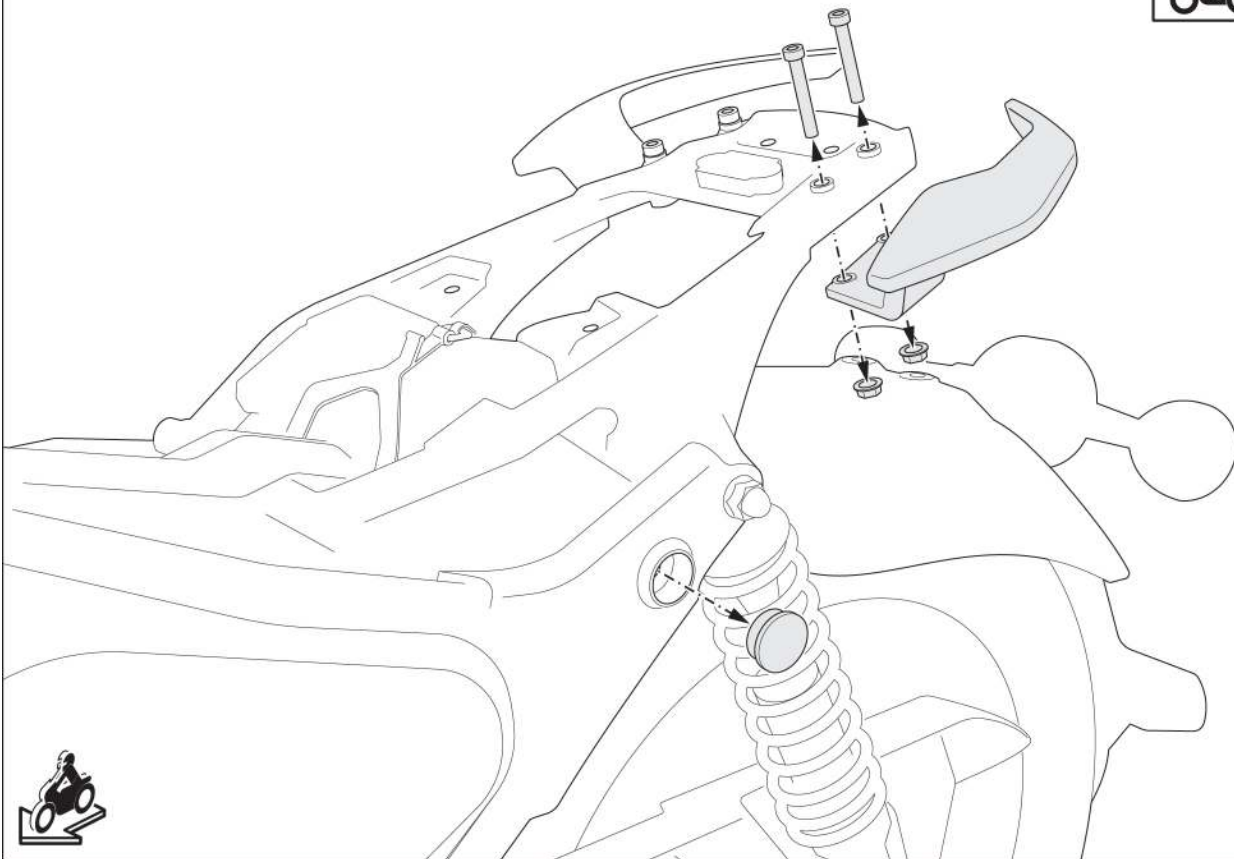

Loosen the screws, and remove the passenger handle from the vehicle.

Remove the frame cover shown.

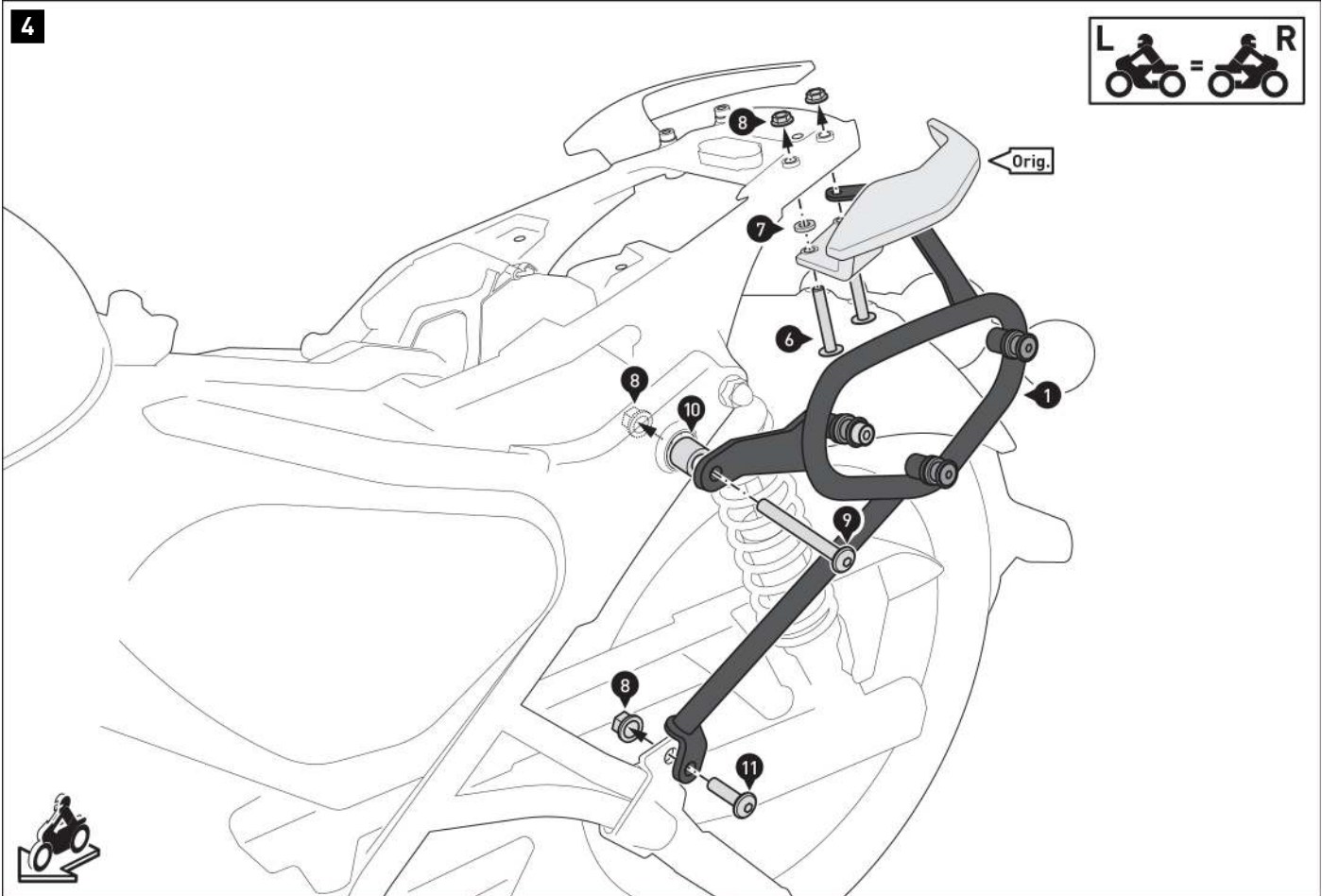

Screw the side carrier (1) to the passenger grab handle (original) on the vehicle.
Tighten the screws as specified in the mounting instructions.

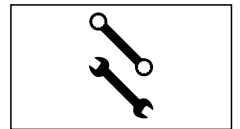
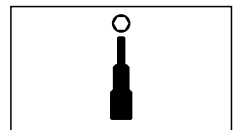
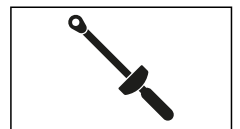
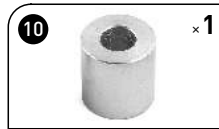

5

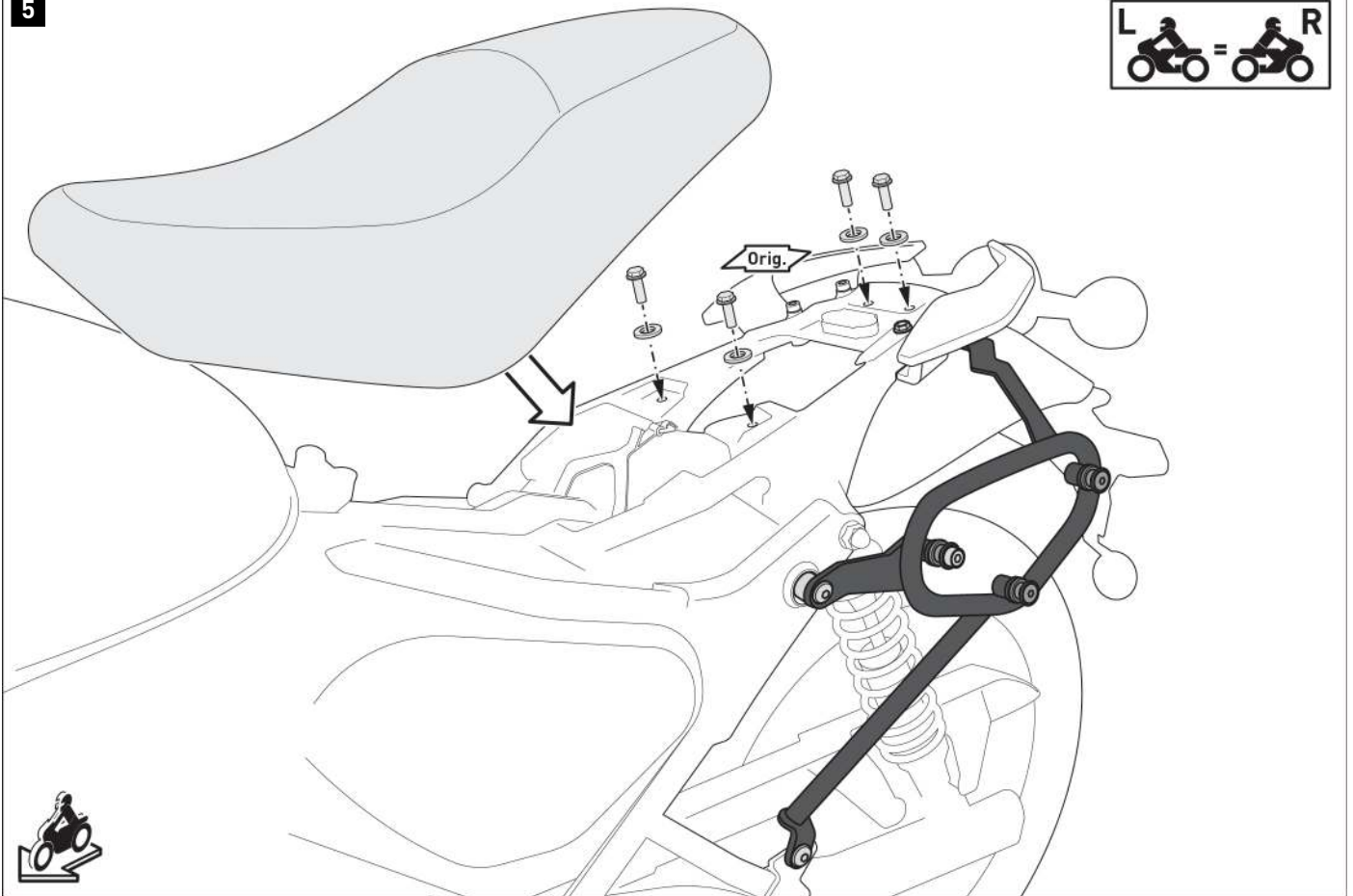

Screw the fender back onto the vehicle.
Tighten the original (Orig.) screws according to the manufacturer's instructions.

Finally, put the seat back on.

PRODUCT-SPECIFIC NOTES

⚠ NOTE: *Observe the country-specific regulations for the registration/operation of your vehicle or applicable TÜV regulations. After assembly, have parts that are subject to registration entered in the vehicle documents by your test centre.*

Art.-Nr. / Item No.: **siehe Stückliste / see parts list**

Revision: **01** · Datum / Date: **06 - 2024**

URBAN ABS Seitenkoffer

URBAN ABS side case

DEUTSCH - Vielen Dank, dass Sie sich für dieses Premium-Produkt von SW-MOTECH entschieden haben. Bitte besuchen Sie unseren Webshop für weitere Informationen wie Modellzuweisungen und PDF-Anbauanleitung. Erforderliche Dokumente (z. B. ABE) stehen als Download zur Verfügung.

Die Montage und / oder Wartung dieses Produkts erfordert ein gutes technisches Verständnis! Zu Ihrer eigenen Sicherheit empfiehlt SW-MOTECH, die Montage und / oder Wartung durch eine Fachwerkstatt durchführen zu lassen! SW-MOTECH übernimmt keine Haftung für Schäden, die durch eine unsachgemäße Montage und / oder Wartung verursacht wurden! Beachten Sie alle in der Anbauanleitung angegebenen Hinweise und die für die Montage relevanten Informationen im Fahrzeughandbuch. Nichtbeachtung kann zu Schäden am Fahrzeug bzw. zur Gefährdung des Fahrers führen! Diese Anbauanleitung ist nach unserem derzeitigen Kenntnisstand verfasst worden. Rechtliche Ansprüche auf Richtigkeit bestehen nicht.

Dieses Produkt wurde für Fahrzeuge im Werkzustand entwickelt. Die Kompatibilität mit Original-Zubehörteilen bzw. den Zubehörteilen anderer Hersteller kann nicht gewährleistet werden. Stellen Sie des Weiteren VOR Montage dieses Produkts sicher, dass sich alle beweglichen Teile (z. B. die Kette) im ursprünglichen Wartungszustand befinden. Montiertes Zubehör kann das Fahrverhalten und/oder die Stabilität Ihres Fahrzeugs verändern.

ALLGEMEINE HINWEISE

Beachten Sie die landesspezifischen Vorschriften für Zulassung / Betrieb Ihres Fahrzeugs bzw. anwendbare TÜV-Vorschriften. Lassen Sie eintragungspflichtige Teile nach Montage durch Ihre Prüfstelle in die Fahrzeugpapiere eintragen.

VORBEREITUNG: Lesen Sie die Anbauanleitung aufmerksam und stellen Sie sicher, dass alle Teile der Stückliste vorhanden sind. Achten Sie darauf, dass Ihr Fahrzeug sicher steht und nicht umfallen kann. Schalten Sie den Motor ab und ziehen Sie den Zündschlüssel. Lassen Sie ggf. den Motor / Auspuff abkühlen. Klemmen Sie bei Arbeiten an der Elektrik die Fahrzeugbatterie ab. Verwenden Sie geeignetes Werkzeug. Lassen Sie sich von einer zweiten Person helfen.

FUNKTIONSKONTROLLE: Da es sich um ein universelles Produkt handelt, stellen Sie unbedingt VOR der ersten Nutzung sicher, dass sich das Produkt ohne Probleme und sachgerecht an Ihrem Fahrzeugtyp befestigen und verwenden lässt. Achten Sie nach der Befestigung auf die uneingeschränkte Freigängigkeit und einwandfreie Funktion sämtlicher Fahrzeugteile. Leuchtmittel wie Rücklicht und Blinker dürfen nicht in ihrer Funktion eingeschränkt werden. Kabel, Züge und Schläuche dürfen nicht scheuern und/oder geklemmt werden. Führen Sie vor Fahrtbeginn eine umfassende Funktionskontrolle durch.

PRODUKTSPEZIFISCHE HINWEISE

ACHTUNG: Das Fahr-/Bremsverhalten des Motorrads verändert sich nach Befestigung dieses Produkts merklich!

ACHTUNG: Überprüfen Sie vor Fahrtbeginn und bei jeder Rast (alle 200 km) den ordnungsgemäßen Sitz des Produkts!

Maximale Zuladung	Höchstgeschwindigkeit
 5 KG (11 lbs)	 130 km/h (80 mph)

ACHTUNG: Die maximale Zuladung des verwendeten SW-MOTECH Seitenträgers darf unter Berücksichtigung des Eigengewichts des Seitenkoffers (1,4 kg) NICHT überschritten werden (siehe Anbauanleitung des SW-MOTECH Seitenträgers)! Es gilt die vom Fahrzeughersteller genannte maximale Zuladung des Fahrzeugs!

ACHTUNG 

NICHT FÜR DEN OFFROAD-EINSATZ GEEIGNET!

ENGLISH - Thank you for choosing this premium product from SW-MOTECH. Please visit our webshop for additional information, such as application charts and PDF mounting instructions. Any other documents that may be required (e.g. ABE certifications), are also available for download at our webshop.

Installation and / or maintenance of this product require good technical understanding! For your own safety SW-MOTECH recommends having installation and / or servicing carried out by a specialist workshop! SW-MOTECH assumes no liability for damage caused by improper installation and / or maintenance work!

Carefully follow all the directions given in the mounting instructions and pay attention to all relevant information in the vehicle manual during assembly. Nonconformance can lead to vehicle damage or even endanger the driver! These mounting instructions are written based on our current state of knowledge. Legal requirements for accuracy do not exist.

This product was developed for vehicles in their factory setting. Compatibility with original accessory parts or other manufacturers' accessory parts is not guaranteed. Furthermore, BEFORE installing this product, make sure that all moving parts (e.g. the chain) are in the original state of maintenance. Installed accessories can change the driving behaviour and / or stability of your vehicle.

GENERAL INFORMATION

Observe the country-specific regulations concerning vehicle registration / operation as well as TÜV regulations if applicable. If required, register installed parts in the vehicle documents through an appropriate inspection authority.

PREPARATION: Read the mounting instructions carefully and make sure that all items of the parts list are included. Make sure that your vehicle is parked safely and cannot fall over. Turn off the engine and remove the ignition key. Let the motor / exhaust cool off if necessary. Disconnect the vehicle battery when working on the electrical system. Use appropriate tools. Have another person to help you.

FUNCTION CHECK: This is a universal product. For this reason make sure BEFORE the first use, that the product can be fixed properly and used without problems with your vehicle type. After fixation also make sure that no moving parts are obstructed and the function of the vehicle is not hindered in any way. Lamps as taillight and turn signals must not be limited in their function. Cables and hoses must not rub and/or be pinched. Before starting to ride, perform a comprehensive check of all functions.

PRODUCT SPECIFIC INFORMATION

ATTENTION: Riding with this product may affect the motorcycles driving and braking performance!

ATTENTION: Before riding and at each stop (every 200 km) check proper fixation of the product!

Maximum Load	Maximum Speed
 5 KG (11 lbs)	 130 km/h (80 mph)

ATTENTION: The maximum load of the used SW-MOTECH side carrier must not be exceeded (refer mounting instructions of the SW-MOTECH side carrier); make sure to take into account the dead weight of the side case (1,4 kg)! The maximum vehicle load specified by the manufacturer must not be exceeded!

ATTENTION 

NOT FOR OFFROAD-USE!

Konfektionierung durch / Packed by:

Datum der Konfektionierung / Date of packaging:



SW-MOTECH GmbH & Co. KG
Ernteweg 8/10
35282 Rauschenberg
Germany

Tel. / phone + 49 (0)6425 / 8168 - 050
Fax / fax + 49 (0)6425 / 8168 - 10
info@sw-motech.com
www.sw-motech.com

STÜCKLISTE / PARTS LIST

Schritt Step	Nr. No.	Art.-Nr. / Bezeichnung * Item No. / Description *	Artikel	Part	Anzahl ** Quantity **	N-m ***
BC.HTA.00.677.10000L/B URBAN ABS Seitenkoffer links URBAN ABS side case left						
1	(1)	BC.HTA.00.677.10000L/B	URBAN ABS Seitenkoffer links	URBAN ABS Side Case left	1 / 1	
2	(2)	BC.LOC.00.001.10200/B	Motorradtaschen-Schloss	Lock for Motorcycle Luggage	1 / 1	
3	(3)	BC.ZUB.00.064.30000	Wasserdichte Innentasche	Waterproof Inner Bag	1 / 1	
BC.HTA.00.677.10000R/B URBAN ABS Seitenkoffer rechts URBAN ABS side case right						
1	(1)	BC.HTA.00.677.10000R/B	URBAN ABS Seitenkoffer rechts	URBAN ABS Side Case right	1 / 1	
2	(2)	BC.LOC.00.001.10200/B	Motorradtaschen-Schloss	Lock for Motorcycle Luggage	1 / 1	
3	(3)	BC.ZUB.00.064.30000	Wasserdichte Innentasche	Waterproof Inner Bag	1 / 1	

8.8	Regelgewinde / Coarse Thread Ø	M4	M5	M6	M8	M10	M12	
	Stahl FK 8.8 / Steel CL 8.8	N-m	2,8	5,5	9,6	23	46	79

10.9	Regelgewinde / Coarse Thread Ø	M4	M5	M6	M8	M10	M12	
	Stahl FK 10.9 / Steel CL 10.9	N-m	4,1	8,1	14	34	67	115

* Alle Maßangaben in Millimeter. - ** Der zweite Wert gibt die Gesamtanzahl des jew. Artikels in der Lieferung an.
 *** **Keine Anzugsmomentvorgabe: Verwenden Sie das vom Fzg.-Hersteller definierte Anzugsmoment!** Das Standard-Anzugsmoment der Tabelle kann verwendet werden, wenn es den Fzg.-Hersteller-Vorgaben entspricht.

* All measurements in millimeters. - ** The second number indicates the total quantity of the part in the delivery.
 *** **No torque specifications: Use the torque defined by vehicle manufacturer!** The standard torque in this table can be used as long as it is within the vehicle manufacturer's specifications.

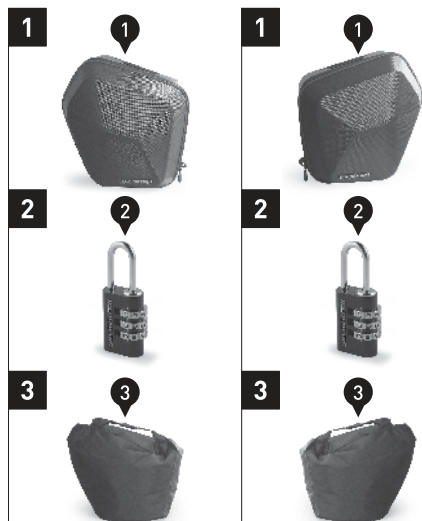

PFLEGE / CARE

Pflege

Verwenden Sie zum Reinigen des Seitenkoffers warme Seifenlauge und ein weiches, sauberes Tuch. Spülen Sie anschließend mit klarem Wasser nach. Verwenden Sie **KEINE** scharfen Reinigungsmittel, raue Putzwerkzeuge oder einen Hochdruckreiniger! Reinigen Sie den Seitenkoffer unbedingt nach Winterfahrten, um Schäden durch das Salz zu vermeiden.

Schwergängige Reißverschlüsse können mit etwas Talkumpulver wieder gängig gemacht werden.

ACHTUNG: Oberflächenmaterialien können bei längerer und intensiver Sonneneinstrahlung und Umwelteinflüssen (z. B. SMOG, saurer Regen, etc.) Farbveränderungen (Ausbleichen) unterliegen! Dafür übernimmt SW-MOTECH keine Haftung.

Care

To clean the side case, use warm, soapy water and a soft, clean cloth. Rinse with clean water. Do **NOT** use strong cleaning agents, rough cleaning tools or high pressure washer!
 Clean the side case after riding in salty conditions, to avoid damage from salt.

Hard to open zippers can be loosened with a small amount of talcum powder.

ATTENTION: Surface materials can experience color changes or fading when exposed to direct sunlight for extended periods of time and by environmental factors (e.g., SMOG, acid rain, etc.)! SW-MOTECH assumes no liability for this.

1

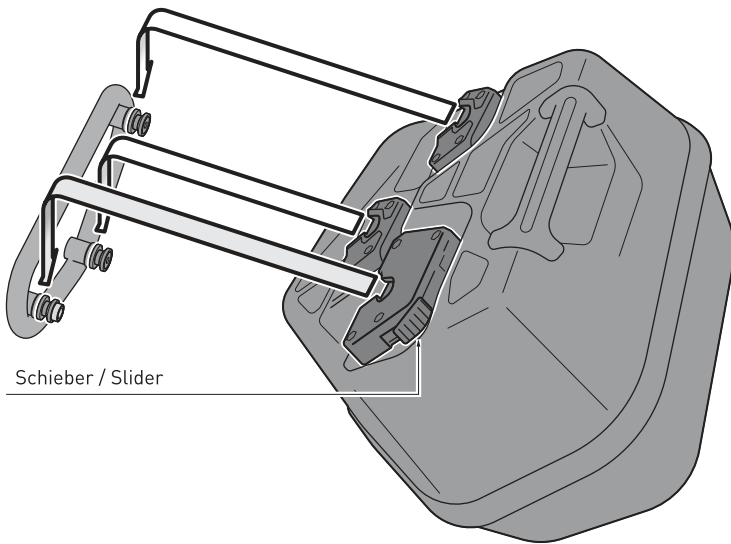

Schieber / Slider

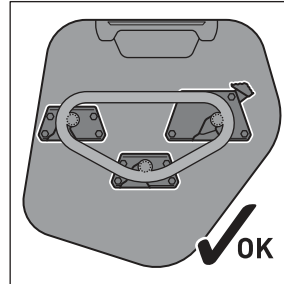
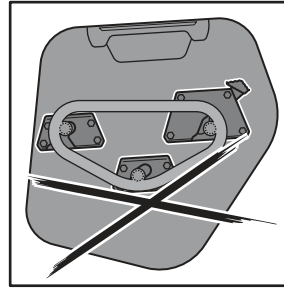

Setzen Sie die drei Arretierungsöffnungen des Seitenkoffers auf die Führungsbolzen des montierten SLC Seitenträgers. Drücken Sie anschließend den Seitenkoffer leicht nach unten, bis dieser fest am SLC Seitenträger sitzt.

ACHTUNG: Achten Sie darauf, dass alle drei Führungsbolzen gleichzeitig einrasten! Achten Sie außerdem auf das deutlich hörbare Einrastgeräusch des Verschlussmechanismus und das die rote Markierung unter dem Schieber nicht sichtbar ist!

Drücken Sie zum Entriegeln den Schieber nach unten.

ACHTUNG: Achten Sie darauf, dass keine Komponenten des Seitenkoffers mit heißen und beweglichen Teilen des Fahrzeugs in Kontakt kommen können! Achten Sie desweiteren darauf, dass alle Komponenten mindestens 5 cm Abstand zu heißen Teilen sowie dem heißen Abgasstrom des Auspuffs haben! Stellen Sie nach der Montage sicher, dass dieser Abstand in jedem Federzustand des Fahrzeugs eingehalten wird!

Place the three locking openings of the side case onto the guide bolts of the mounted SLC side carrier. Then press the side case slightly downward, until it properly rests on the SLC side carrier.

ATTENTION: Make sure that all three guide bolts engage at the same time! Pay attention to the clearly audible snap sound of the locking mechanism and that the red marking under the slider is not visible!

To release press the slider downward.

ATTENTION: All components of the side case must not contact any hot or moving parts of the vehicle! All parts should also remain 5 cm away from hot parts of the vehicle and remain clear of the exhaust stream! After mounting, make sure there are no clearance issues while the suspension is both compressed and extended.

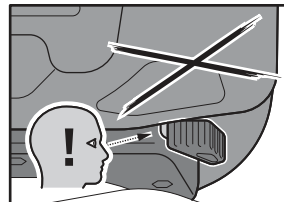

SICHTBARE ROTE MARKIERUNG: NICHT korrekt verriegelt! Verlustgefahr!
VISIBLE RED MARKING: NOT correctly locked! Risk of loss!

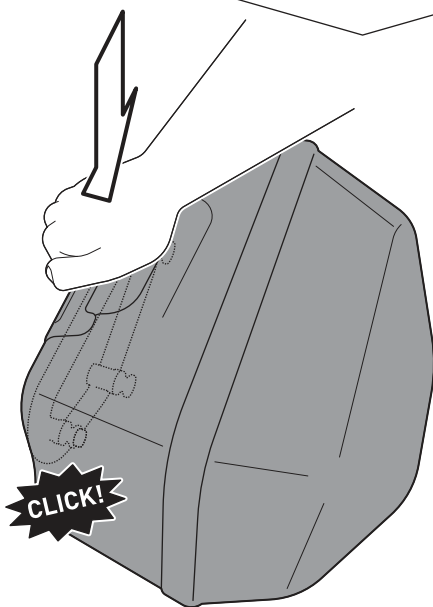
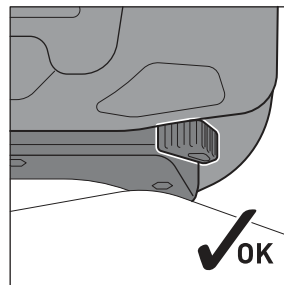

2

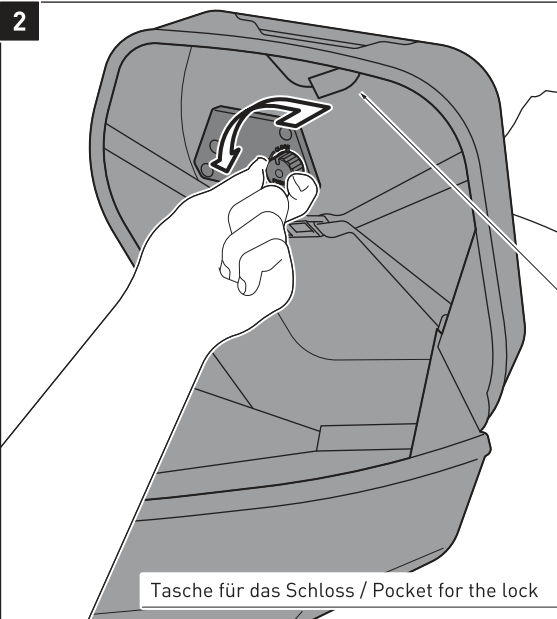

Tasche für das Schloss / Pocket for the lock

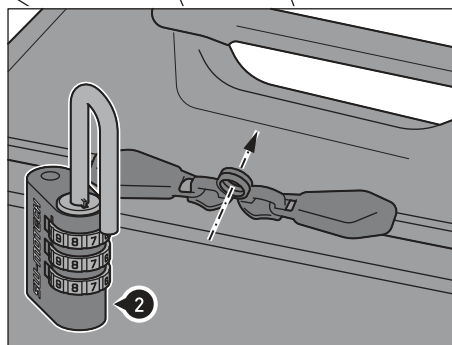
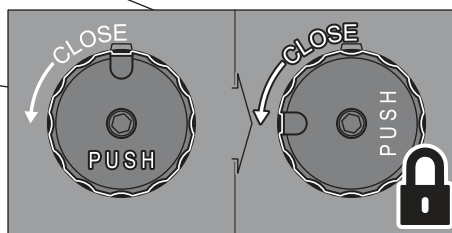

Um den montierten Seitenkoffer (1) gegen Diebstahl zu schützen, muss dieser zunächst geöffnet werden.

Drücken Sie nun den Sicherungsknopf und drehen ihn gemäß der Pfeilmarkierung, bis der Sicherungsknopf einrastet.

Verriegeln Sie nun die Puller des geschlossenen Reißverschluss mit dem beiliegenden Schloss (2).

Wir empfehlen, den Sicherungsknopf während der Fahrt immer in der abgeschlossenen Position zu belassen.

Open the mounted side case (1) to protect it against theft.

Now press the locking button and turn it according to the arrow mark until the locking button engages.

Then lock the closed zipper with the included lock (2)

We recommend leaving the locking button in the closed position during the ride.

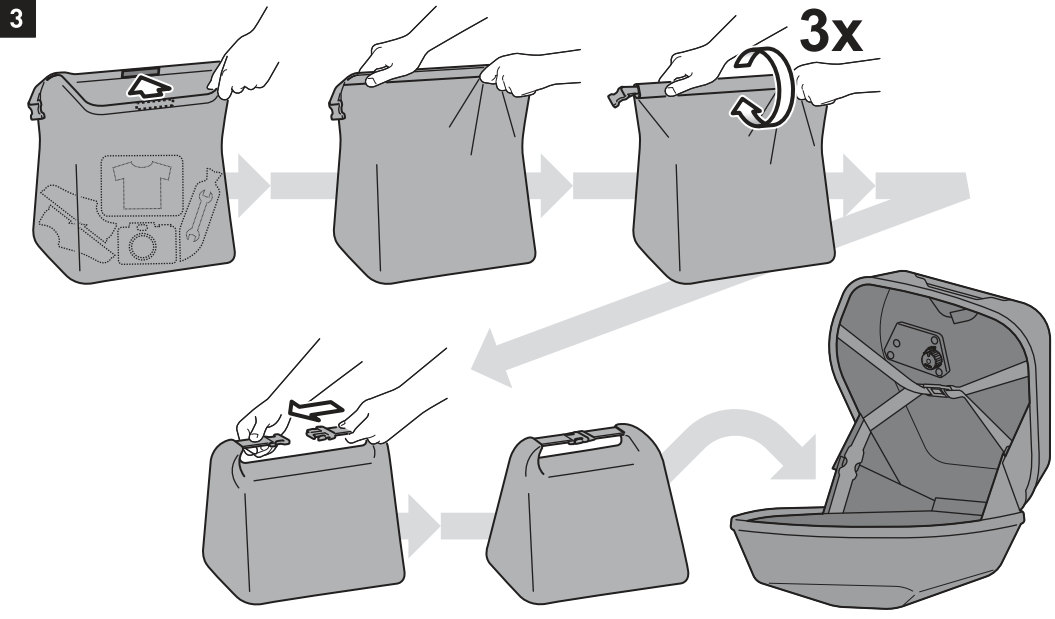

Verwenden Sie die beiliegende wasserdichte Innentasche (3), um Ihr Gepäck vor Feuchtigkeit zu schützen.

Use the included waterproof innerbag (3) to protect your luggage from moisture.

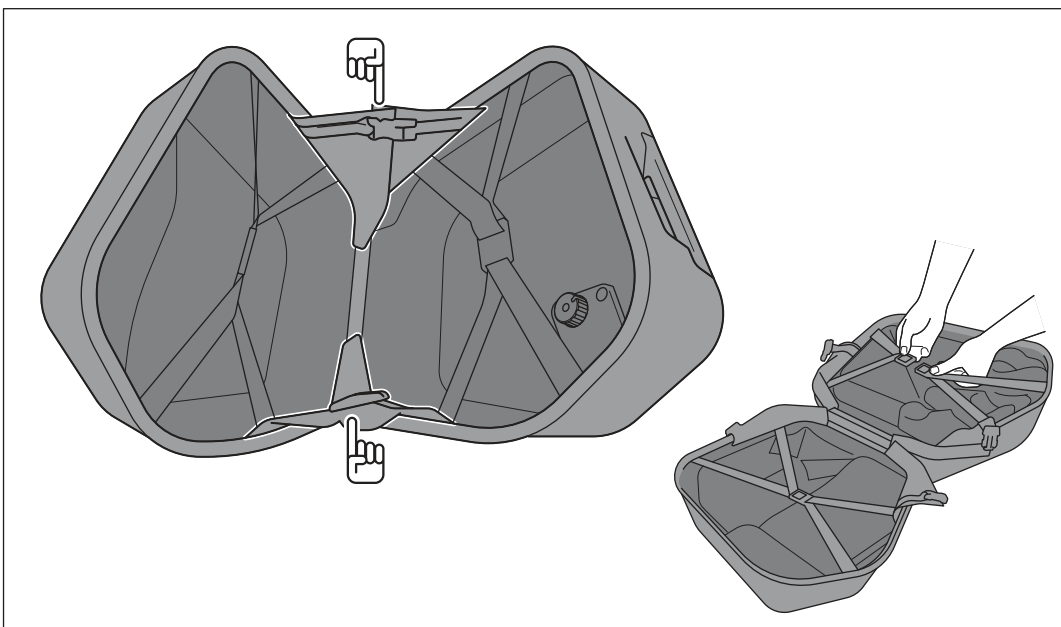

Um den Seitenkoffer(1) einfacher beladen zu können, öffnen Sie die Schnallen und Klettverschlüsse der Öffnungsreduzierungen, wie in der Zeichnung gezeigt.

For an easier loading of the side case (1), open the buckles and hook and loop fasteners of the opening reductions, as shown in the drawing.

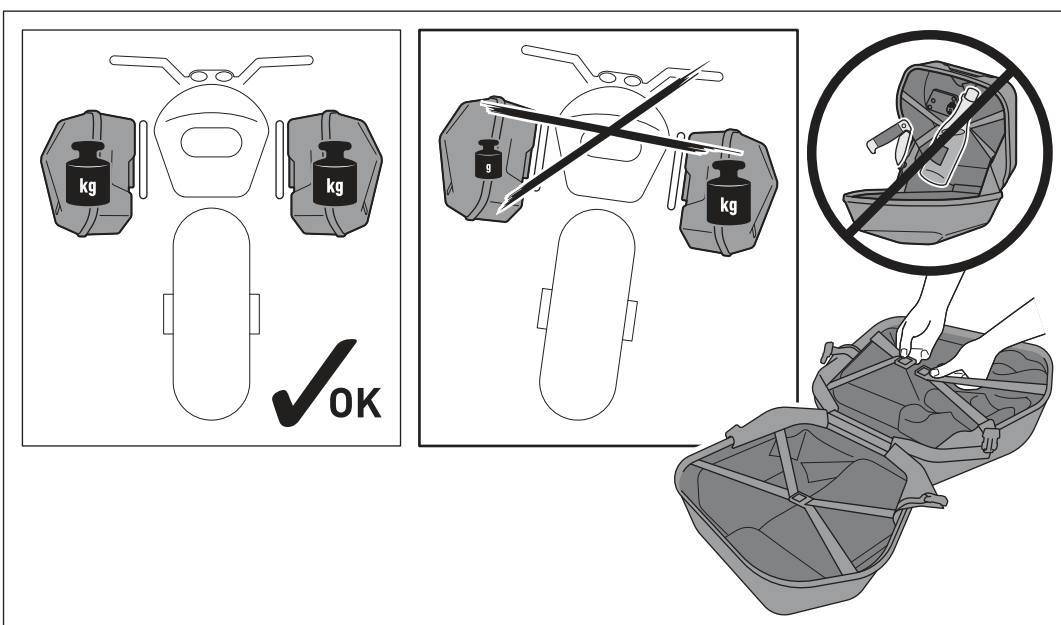

ACHTUNG: Achten Sie bei beidseitiger Verwendung der Seitenkoffer auf die gleichmäßige Verteilung der Ladung! Stellen Sie sicher, dass die Ladung während der Fahrt gegen Verrutschen gesichert ist!

ACHTUNG: Achten Sie darauf, niemals scharfkantige, spitze oder ähnliche Gegenstände zu verstauen, welche Verletzungen an Personen bzw. Beschädigungen am Fahrzeug/Seitenkoffer verursachen könnten!

ATTENTION: Make sure weight is evenly distributed between the left and right side if you want to use both side cases! Make sure that the loading is secured against shifting during the ride!

ATTENTION: Never store pointy or sharp-edged objects, which could cause injury to persons or damage to the vehicle/side case!

Art.-Nr. / Item No.: **siehe Stückliste / see parts list**

Revision: **01** · Datum / Date: **06 - 2024**

URBAN ABS Seitenkoffer

URBAN ABS side case

DEUTSCH - Vielen Dank, dass Sie sich für dieses Premium-Produkt von SW-MOTECH entschieden haben. Bitte besuchen Sie unseren Webshop für weitere Informationen wie Modellzuweisungen und PDF-Anbauanleitung. Erforderliche Dokumente (z. B. ABE) stehen als Download zur Verfügung.

Die Montage und / oder Wartung dieses Produkts erfordert ein gutes technisches Verständnis! Zu Ihrer eigenen Sicherheit empfiehlt SW-MOTECH, die Montage und / oder Wartung durch eine Fachwerkstatt durchführen zu lassen! SW-MOTECH übernimmt keine Haftung für Schäden, die durch eine unsachgemäße Montage und / oder Wartung verursacht wurden!

Beachten Sie alle in der Anbauanleitung angegebenen Hinweise und die für die Montage relevanten Informationen im Fahrzeughandbuch. Nichtbeachtung kann zu Schäden am Fahrzeug bzw. zur Gefährdung des Fahrers führen! Diese Anbauanleitung ist nach unserem derzeitigen Kenntnisstand verfasst worden. Rechtliche Ansprüche auf Richtigkeit bestehen nicht.

Dieses Produkt wurde für Fahrzeuge im Werkzustand entwickelt. Die Kompatibilität mit Original-Zubehörteilen bzw. den Zubehörteilen anderer Hersteller kann nicht gewährleistet werden. Stellen Sie des Weiteren VOR Montage dieses Produkts sicher, dass sich alle beweglichen Teile (z. B. die Kette) im ursprünglichen Wartungszustand befinden. Montiertes Zubehör kann das Fahrverhalten und/oder die Stabilität Ihres Fahrzeugs verändern.

ALLGEMEINE HINWEISE

Beachten Sie die landesspezifischen Vorschriften für Zulassung / Betrieb Ihres Fahrzeugs bzw. anwendbare TÜV-Vorschriften. Lassen Sie eintragungspflichtige Teile nach Montage durch Ihre Prüfstelle in die Fahrzeugpapiere eintragen.

VORBEREITUNG: Lesen Sie die Anbauanleitung aufmerksam und stellen Sie sicher, dass alle Teile der Stückliste vorhanden sind. Achten Sie darauf, dass Ihr Fahrzeug sicher steht und nicht umfallen kann. Schalten Sie den Motor ab und ziehen Sie den Zündschlüssel. Lassen Sie ggf. den Motor / Auspuff abkühlen. Klemmen Sie bei Arbeiten an der Elektrik die Fahrzeugbatterie ab. Verwenden Sie geeignetes Werkzeug. Lassen Sie sich von einer zweiten Person helfen.

FUNKTIONSKONTROLLE: Da es sich um ein universelles Produkt handelt, stellen Sie unbedingt VOR der ersten Nutzung sicher, dass sich das Produkt ohne Probleme und sachgerecht an Ihrem Fahrzeugtyp befestigen und verwenden lässt. Achten Sie nach der Befestigung auf die uneingeschränkte Freigängigkeit und einwandfreie Funktion sämtlicher Fahrzeugteile. Leuchtmittel wie Rücklicht und Blinker dürfen nicht in ihrer Funktion eingeschränkt werden. Kabel, Züge und Schläuche dürfen nicht scheuern und/oder geklemmt werden. Führen Sie vor Fahrtbeginn eine umfassende Funktionskontrolle durch.

PRODUKTSPEZIFISCHE HINWEISE

ACHTUNG: Das Fahr-/Bremsverhalten des Motorrads verändert sich nach Befestigung dieses Produkts merklich!

ACHTUNG: Überprüfen Sie vor Fahrtbeginn und bei jeder Rast (alle 200 km) den ordnungsgemäßen Sitz des Produkts!

Maximale Zuladung	Höchstgeschwindigkeit
 5 KG (11 lbs)	 130 km/h (80 mph)

ACHTUNG: Die maximale Zuladung des verwendeten SW-MOTECH Seitenträgers darf unter Berücksichtigung des Eigengewichts des Seitenkoffers (1,4 kg) NICHT überschritten werden (siehe Anbauanleitung des SW-MOTECH Seitenträgers)! Es gilt die vom Fahrzeughersteller genannte maximale Zuladung des Fahrzeugs!

ACHTUNG 

NICHT FÜR DEN OFFROAD-EINSATZ GEEIGNET!

ENGLISH - Thank you for choosing this premium product from SW-MOTECH. Please visit our webshop for additional information, such as application charts and PDF mounting instructions. Any other documents that may be required (e.g. ABE certifications), are also available for download at our webshop.

Installation and / or maintenance of this product require good technical understanding! For your own safety SW-MOTECH recommends having installation and / or servicing carried out by a specialist workshop! SW-MOTECH assumes no liability for damage caused by improper installation and / or maintenance work!

Carefully follow all the directions given in the mounting instructions and pay attention to all relevant information in the vehicle manual during assembly. Nonconformance can lead to vehicle damage or even endanger the driver! These mounting instructions are written based on our current state of knowledge. Legal requirements for accuracy do not exist.

This product was developed for vehicles in their factory setting. Compatibility with original accessory parts or other manufacturers' accessory parts is not guaranteed. Furthermore, BEFORE installing this product, make sure that all moving parts (e.g. the chain) are in the original state of maintenance. Installed accessories can change the driving behaviour and / or stability of your vehicle.

GENERAL INFORMATION

Observe the country-specific regulations concerning vehicle registration / operation as well as TÜV regulations if applicable. If required, register installed parts in the vehicle documents through an appropriate inspection authority.

PREPARATION: Read the mounting instructions carefully and make sure that all items of the parts list are included. Make sure that your vehicle is parked safely and cannot fall over. Turn off the engine and remove the ignition key. Let the motor / exhaust cool off if necessary. Disconnect the vehicle battery when working on the electrical system. Use appropriate tools. Have another person to help you.

FUNCTION CHECK: This is a universal product. For this reason make sure BEFORE the first use, that the product can be fixed properly and used without problems with your vehicle type. After fixation also make sure that no moving parts are obstructed and the function of the vehicle is not hindered in any way. Lamps as taillight and turn signals must not be limited in their function. Cables and hoses must not rub and/or be pinched. Before starting to ride, perform a comprehensive check of all functions.

PRODUCT SPECIFIC INFORMATION

ATTENTION: Riding with this product may affect the motorcycles driving and braking performance!

ATTENTION: Before riding and at each stop (every 200 km) check proper fixation of the product!

Maximum Load	Maximum Speed
 5 KG (11 lbs)	 130 km/h (80 mph)

ATTENTION: The maximum load of the used SW-MOTECH side carrier must not be exceeded (refer mounting instructions of the SW-MOTECH side carrier); make sure to take into account the dead weight of the side case (1,4 kg)! The maximum vehicle load specified by the manufacturer must not be exceeded!

ATTENTION 

NOT FOR OFFROAD-USE!

Konfektionierung durch / Packed by:

Datum der Konfektionierung / Date of packaging:



SW-MOTECH GmbH & Co. KG
Ernteweg 8/10
35282 Rauschenberg
Germany

Tel. / phone + 49 (0)6425 / 8168 - 050
Fax / fax + 49 (0)6425 / 8168 - 10
info@sw-motech.com
www.sw-motech.com

STÜCKLISTE / PARTS LIST

Schritt Step	Nr. No.	Art.-Nr. / Bezeichnung * Item No. / Description *	Artikel	Part	Anzahl ** Quantity **	N-m ***
		BC.HTA.00.677.10000L/B	URBAN ABS Seitenkoffer links	URBAN ABS side case left		
1	(1)	BC.HTA.00.677.10000L/B	URBAN ABS Seitenkoffer links	URBAN ABS Side Case left	1 /1	
2	(2)	BC.LOC.00.001.10200/B	Motorradtaschen-Schloss	Lock for Motorcycle Luggage	1 /1	
3	(3)	BC.ZUB.00.064.30000	Wasserdichte Innentasche	Waterproof Inner Bag	1 /1	
		BC.HTA.00.677.10000R/B	URBAN ABS Seitenkoffer rechts	URBAN ABS side case right		
1	(1)	BC.HTA.00.677.10000R/B	URBAN ABS Seitenkoffer rechts	URBAN ABS Side Case right	1 /1	
2	(2)	BC.LOC.00.001.10200/B	Motorradtaschen-Schloss	Lock for Motorcycle Luggage	1 /1	
3	(3)	BC.ZUB.00.064.30000	Wasserdichte Innentasche	Waterproof Inner Bag	1 /1	

8.8	Regelgewinde / Coarse Thread Ø	M4	M5	M6	M8	M10	M12
	Stahl FK 8.8 / Steel CL 8.8	N-m	2,8	5,5	9,6	23	46 79

10.9	Regelgewinde / Coarse Thread Ø	M4	M5	M6	M8	M10	M12
	Stahl FK 10.9 / Steel CL 10.9	N-m	4,1	8,1	14	34	67 115

* Alle Maßangaben in Millimeter. - ** Der zweite Wert gibt die Gesamtanzahl des jew. Artikels in der Lieferung an.
 *** **Keine Anzugsmomentvorgabe: Verwenden Sie das vom Fzg.-Hersteller definierte Anzugsmoment!** Das Standard-Anzugsmoment der Tabelle kann verwendet werden, wenn es den Fzg.-Hersteller-Vorgaben entspricht.

* All measurements in millimeters. - ** The second number indicates the total quantity of the part in the delivery.
 *** **No torque specifications: Use the torque defined by vehicle manufacturer!** The standard torque in this table can be used as long as it is within the vehicle manufacturer's specifications.

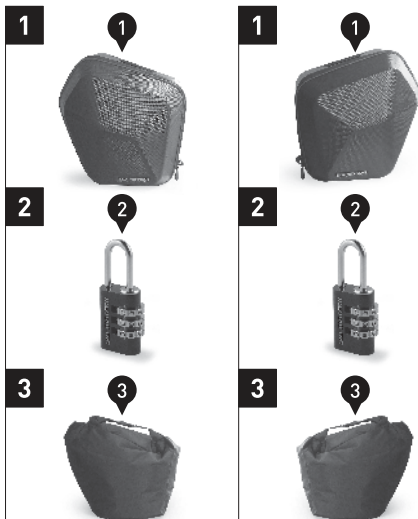

PFLEGE / CARE

Pflege

Verwenden Sie zum Reinigen des Seitenkoffers warme Seifenlauge und ein weiches, sauberes Tuch. Spülen Sie anschließend mit klarem Wasser nach. Verwenden Sie **KEINE** scharfen Reinigungsmittel, raue Putzwerkzeuge oder einen Hochdruckreiniger! Reinigen Sie den Seitenkoffer unbedingt nach Winterfahrten, um Schäden durch das Salz zu vermeiden.

Schwergängige Reißverschlüsse können mit etwas Talkumpulver wieder gängig gemacht werden.

ACHTUNG: Oberflächenmaterialien können bei längerer und intensiver Sonneneinstrahlung und Umwelteinflüssen (z. B. SMOG, saurer Regen, etc.) Farbveränderungen (Ausbleichen) unterliegen! Dafür übernimmt SW-MOTECH keine Haftung.

Care

To clean the side case, use warm, soapy water and a soft, clean cloth. Rinse with clean water. Do **NOT** use strong cleaning agents, rough cleaning tools or high pressure washer!
 Clean the side case after riding in salty conditions, to avoid damage from salt.

Hard to open zippers can be loosened with a small amount of talcum powder.

ATTENTION: Surface materials can experience color changes or fading when exposed to direct sunlight for extended periods of time and by environmental factors (e.g., SMOG, acid rain, etc.)! SW-MOTECH assumes no liability for this.

1

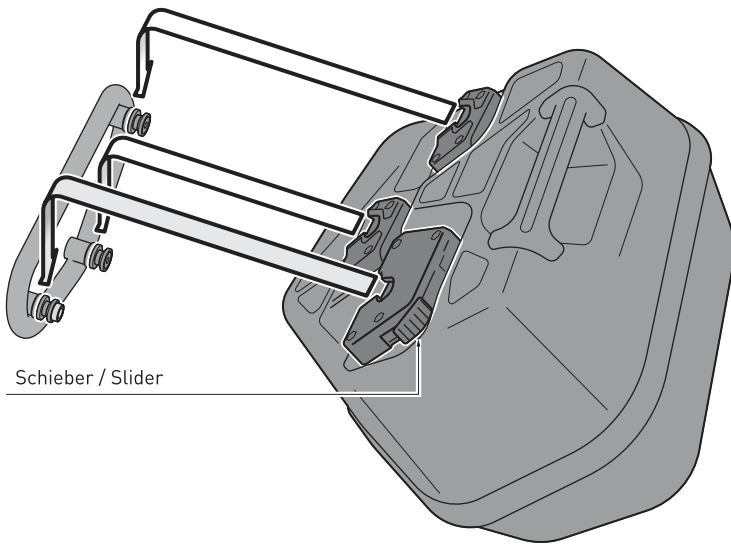

Schieber / Slider

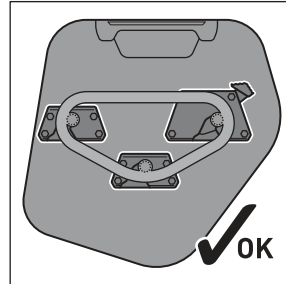
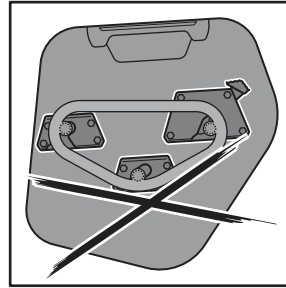

Setzen Sie die drei Arretierungsöffnungen des Seitenkoffers auf die Führungsbolzen des montierten SLC Seitenträgers. Drücken Sie anschließend den Seitenkoffer leicht nach unten, bis dieser fest am SLC Seitenträger sitzt.

ACHTUNG: Achten Sie darauf, dass alle drei Führungsbolzen gleichzeitig einrasten! Achten Sie außerdem auf das deutlich hörbare Einrastgeräusch des Verschlussmechanismus und das die rote Markierung unter dem Schieber nicht sichtbar ist!

Drücken Sie zum Entriegeln den Schieber nach unten.

ACHTUNG: Achten Sie darauf, dass keine Komponenten des Seitenkoffers mit heißen und beweglichen Teilen des Fahrzeugs in Kontakt kommen können! Achten Sie desweiteren darauf, dass alle Komponenten mindestens 5 cm Abstand zu heißen Teilen sowie dem heißen Abgasstrom des Auspuffs haben! Stellen Sie nach der Montage sicher, dass dieser Abstand in jedem Federzustand des Fahrzeugs eingehalten wird!

Place the three locking openings of the side case onto the guide bolts of the mounted SLC side carrier. Then press the side case slightly downward, until it properly rests on the SLC side carrier.

ATTENTION: Make sure that all three guide bolts engage at the same time! Pay attention to the clearly audible snap sound of the locking mechanism and that the red marking under the slider is not visible!

To release press the slider downward.

ATTENTION: All components of the side case must not contact any hot or moving parts of the vehicle! All parts should also remain 5 cm away from hot parts of the vehicle and remain clear of the exhaust stream! After mounting, make sure there are no clearance issues while the suspension is both compressed and extended.

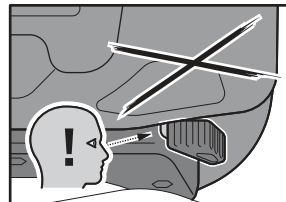

SICHTBARE ROTE MARKIERUNG: NICHT korrekt verriegelt! Verlustgefahr!
VISIBLE RED MARKING: NOT correctly locked! Risk of loss!

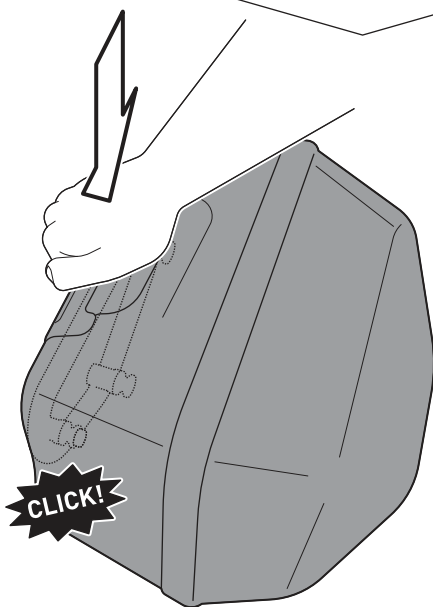
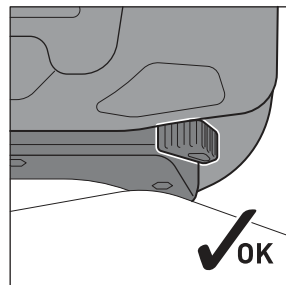

2

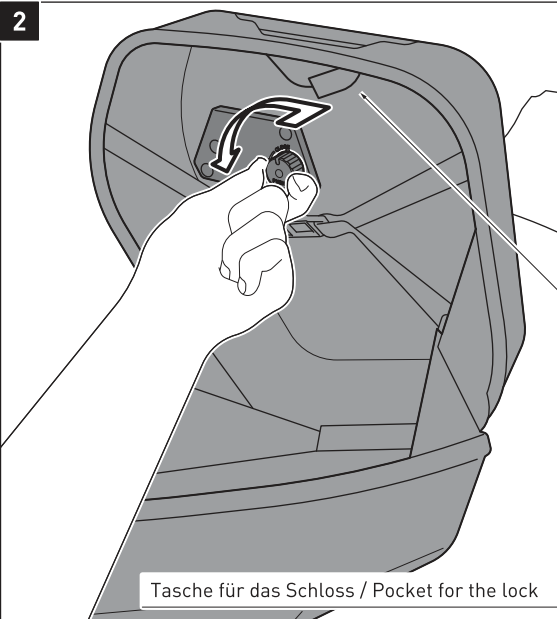

Tasche für das Schloss / Pocket for the lock

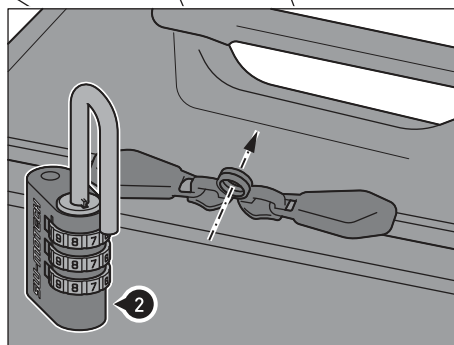
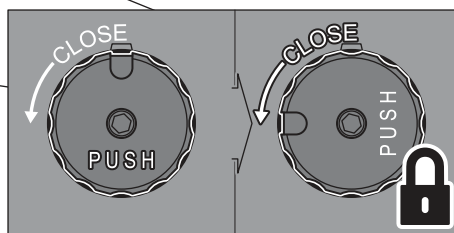

Um den montierten Seitenkoffer (1) gegen Diebstahl zu schützen, muss dieser zunächst geöffnet werden.

Drücken Sie nun den Sicherungsknopf und drehen ihn gemäß der Pfeilmarkierung, bis der Sicherungsknopf einrastet.

Verriegeln Sie nun die Puller des geschlossenen Reißverschluss mit dem beiliegenden Schloss (2).

Wir empfehlen, den Sicherungsknopf während der Fahrt immer in der abgeschlossenen Position zu belassen.

Open the mounted side case (1) to protect it against theft.

Now press the locking button and turn it according to the arrow mark until the locking button engages.

Then lock the closed zipper with the included lock (2)

We recommend leaving the locking button in the closed position during the ride.

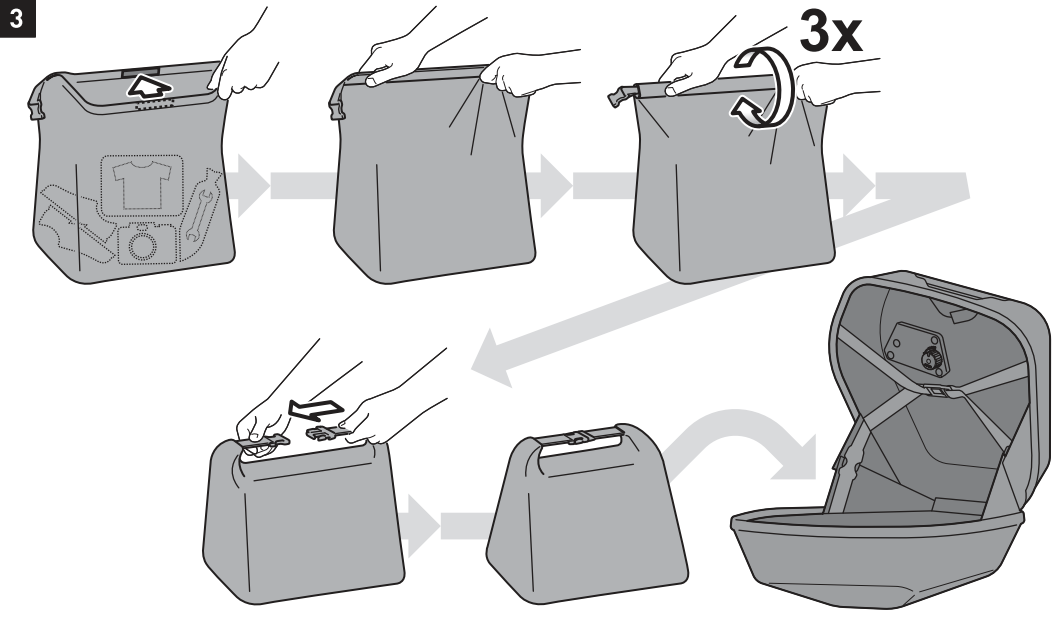

Verwenden Sie die beiliegende wasserdichte Innentasche (3), um Ihr Gepäck vor Feuchtigkeit zu schützen.

Use the included waterproof innerbag (3) to protect your luggage from moisture.

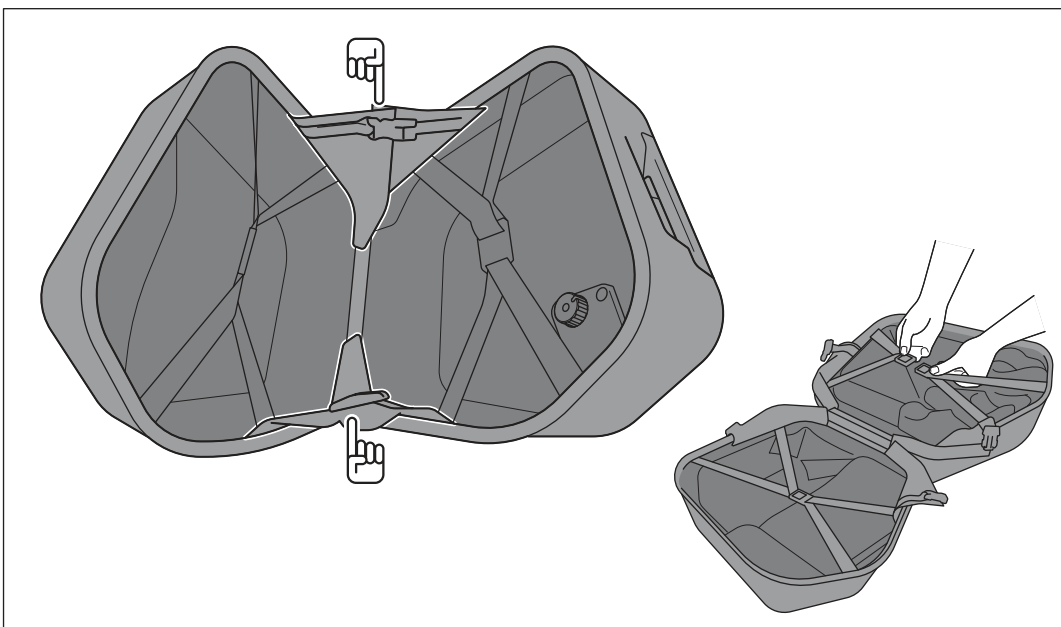

Um den Seitenkoffer(1) einfacher beladen zu können, öffnen Sie die Schnallen und Klettverschlüsse der Öffnungsreduzierungen, wie in der Zeichnung gezeigt.

For an easier loading of the side case (1), open the buckles and hook and loop fasteners of the opening reductions, as shown in the drawing.

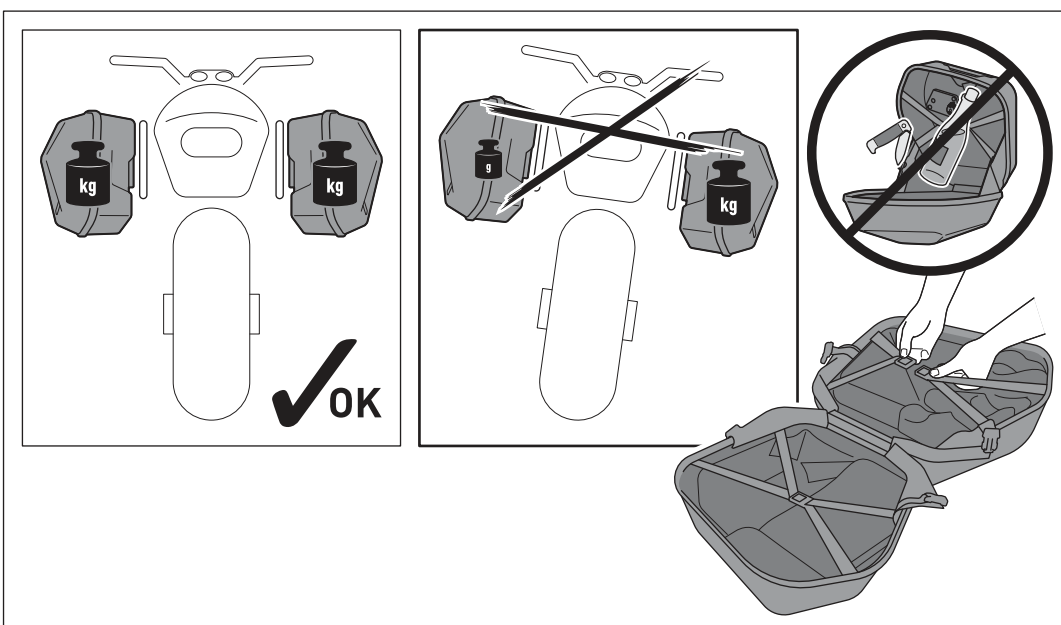

ACHTUNG: Achten Sie bei beidseitiger Verwendung der Seitenkoffer auf die gleichmäßige Verteilung der Ladung! Stellen Sie sicher, dass die Ladung während der Fahrt gegen Verrutschen gesichert ist!

ACHTUNG: Achten Sie darauf, niemals scharfkantige, spitze oder ähnliche Gegenstände zu verstauen, welche Verletzungen an Personen bzw. Beschädigungen am Fahrzeug/Seitenkoffer verursachen könnten!

ATTENTION: Make sure weight is evenly distributed between the left and right side if you want to use both side cases! Make sure that the loading is secured against shifting during the ride!

ATTENTION: Never store pointy or sharp-edged objects, which could cause injury to persons or damage to the vehicle/side case!