

# ANBAUANLEITUNG

mounting instructions • instructions de montage • instrucciones de montaje • istruzioni di montaggio

## **KFT.01.841.65100/B**

beinhaltet • contains • contient • contiene • contiene

KFT.01.841.30000/B

KFT.00.152.36000

HSK.00.745.11000/B

LOC.00.745.10200

Art.-Nr. / Item No.: **KFT.01.841.30000/B**

Revision: **01** · Datum / Date: **12 - 2021**

**PRO Seitenträger**

**PRO side carrier**

**DEUTSCH** · Vielen Dank, dass Sie sich für dieses Premium-Produkt von SW-MOTECH entschieden haben. Bitte lesen und verstehen Sie alle Anweisungen, Sicherheitshinweise und Warnungen in dieser Anbauanleitung vor Montage und Nutzung des Produkts, um Verletzungen zu vermeiden. Dieses Produkt wurde für Fahrzeuge im Werkszustand entwickelt. Die Kompatibilität mit Original-Zubehörteilen bzw. den Zubehörteilen anderer Hersteller kann nicht gewährleistet werden. Besuchen Sie unseren Webshop für weitere Informationen wie Modellzuweisungen und PDF-Anbauanleitung. Erforderliche Dokumente (z. B. ABE) stehen als Download zur Verfügung. Bewahren Sie diese Anbauanleitung als Referenz auf.

SW-MOTECH übernimmt keine Haftung für Schäden, die durch eine unsachgemäße Montage und/oder Wartung verursacht wurden!

**SICHERHEITSWARNUNGSSYMBOL**

**⚠** Dieses Warnsymbol wird in dieser Anbauanleitung verwendet, um vor tödlichen Gefahren, Verletzungen oder anderen Gefahren zu warnen. Die Wörter **GEFAHR**, **WARNUNG** oder **VORSICHT** werden mit diesem Warnsymbol verwendet, um wichtige Sicherheitshinweise und Informationen in Bezug auf die Montage und Nutzung dieses Produkts zu übermitteln. Diese Wörter zusammen mit dem Sicherheitswarnsymbol bedeuten:

**⚠ GEFAHR:** Weist auf eine gefährliche Situation hin, die zum Tod oder zu schweren Verletzungen führt, wenn sie nicht vermieden wird!

**⚠ WARNUNG:** Weist auf eine gefährliche Situation hin, die zum Tod oder zu schweren Verletzungen führen kann, wenn sie nicht vermieden wird!

**⚠ VORSICHT:** Weist auf eine gefährliche Situation hin, die zu leichten oder mittelschweren Verletzungen führen kann, wenn sie nicht vermieden wird!

**⚠ HINWEIS:** Wichtige Informationen, jedoch nicht in Bezug auf Todes- oder Verletzungsgefahr (nur Sachschäden)!

**⚠ WARNUNG:** Die Montage und/oder Wartung dieses Produkts erfordert fortgeschrittene technische Fähigkeiten, passende Werkzeuge und ein gutes Verständnis der Werkzeugnutzung und Drehmomentangaben. Zu Ihrer Sicherheit empfiehlt SW-MOTECH, die Montage und/oder Wartung von einem qualifizierten und zertifizierten Zweiradmechaniker durchführen zu lassen.

**⚠ WARNUNG:** Wenn Sie sich für die Eigenmontage dieses Produkts entscheiden, lesen Sie vor Montage und Nutzung die Anbauanleitung sorgfältig und vollständig durch und befolgen Sie alle Anweisungen, um schwere oder tödliche Verletzungen zu vermeiden. Beachten Sie bei der Montage und Verwendung auch alle relevanten Informationen im Fahrzeughandbuch. **WENN SIE EINEN TEIL DIESER ANBAUANLEITUNG NICHT VERSTEHEN ODER EINE ERKLÄRUNG EINER ANWEISUNG BENÖTIGEN, VERSUCHEN SIE NICHT, DIESES PRODUKT ZU MONTIEREN OHNE SW-MOTECH UM HILFE ZU FRAGEN.**

**VORBEREITUNG:** Lesen Sie die Anbauanleitung aufmerksam und stellen Sie sicher, dass alle Teile der Stückliste vorhanden sind.

**⚠ VORSICHT:** Achten Sie auf den sicheren Stand Ihres Fahrzeugs. Schalten Sie den Motor ab und ziehen Sie den Zündschlüssel. Den Motor/Auspuff bei Bedarf abkühlen lassen. Klemmen Sie die Batterie bei Arbeiten an der Elektrik ab. Verwenden Sie geeignetes Werkzeuge und tragen Sie immer eine Schutzbrille und Handschuhe. Lassen Sie sich von einer zweiten Person helfen.

**MONTAGE:** Alle vom Fahrzeug entfernten Teile und Verbindungen müssen gemäß den Angaben des Fahrzeugherstellers wieder eingebaut oder durch von SW-MOTECH gelieferte Teile und Hardware ersetzt werden.

**⚠ WARNUNG:** Sichern Sie alle Gewinde, sofern nicht anders angegeben, mit mittelstarker, flüssiger Schraubensicherung. Von SW-MOTECH nicht definierte Drehmomentspezifikationen müssen vom Fahrzeughersteller oder von einer zertifizierten Motorradwerkstatt bezogen werden!

**FUNKTIONSKONTROLLE:** Stellen Sie nach der Montage sicher, dass keine beweglichen Teile blockiert und die Funktion des Fahrzeugs nicht gestört wird. Kabel und Schläuche dürfen nicht scheuern und/oder geklemmt werden.

**⚠ WARNUNG:** Führen Sie vor Fahrtbeginn eine umfassende Funktionskontrolle durch. Prüfen Sie nach den ersten 50 km und dann regelmäßig das Anzugsmoment aller Verbindungen und den festen Sitz des Produkts. Montiertes Zubehör kann Fahrverhalten/Stabilität des Fahrzeugs verändern.

**ENGLISH** · Thank you for choosing this premium product from SW-MOTECH. Please carefully read and understand all instructions, safety messages and warnings in this mounting instructions prior to installation and use of this product to avoid injury.

This product was developed for vehicles in their factory setting. Compatibility with original accessory parts or other manufacturers' accessory parts is not guaranteed. Visit our webshop for additional information, such as application charts and PDF mounting instructions. Any other documents that may be required (e.g. ABE certifications), are also available for download at our webshop. Keep these mounting instructions as reference.

SW-MOTECH assumes no liability for damage caused by improper installation and/or maintenance work!

**SAFETY ALERT SYMBOL**

**⚠** This safety alert symbol is used throughout these mounting instructions to warn of the possibility of death, bodily injury or other warnings. The words **DANGER**, **WARNING** and **CAUTION** are used with this safety alert symbol to convey important safety messages and information related to the installation and use of this product. These words along with the safety alert symbol mean:

**⚠ DANGER:** Indicates a hazardous situation that, if not avoided, will result in death or serious injury!

**⚠ WARNING:** Indicates a hazardous situation that, if not avoided, could result in death or serious injury!

**⚠ CAUTION:** Indicates a hazardous situation that, if not avoided, could result in minor or moderate injury!

**⚠ NOTICE:** Important information, but not death or injury related (property damage only)!

**⚠ WARNING:** The installation and/or maintenance of this product requires advanced mechanical skills, the proper tools, and a thorough understanding of tool use and torque specifications.

For your own safety, SW-MOTECH recommends having installation and/or maintenance carried out by a qualified and certified motorcycle mechanic.

**⚠ WARNING:** Should you choose to self-install this product, carefully and completely read all intallation and safety instructions before installation and use, and follow all the directions and safety precautions given in the mounting instructions to avoid serious injury or death. Also pay attention to all relevant information in the vehicle manual during intallation and use. **IF YOU DO NOT UNDERSTAND ANY PART OF THESE INSTRUCTIONS, OR NEED CLARIFICATION OF ANY INSTRUCTION, DO NOT ATTEMPT TO MOUNT THIS PRODUCT WITHOUT CONTACTING SW-MOTECH FOR ASSISTANCE.**

**PREPARATION:** Read the mounting instructions carefully and make sure that all items of the parts list are included.

**⚠ CAUTION:** Make sure that your vehicle is parked safely and cannot fall over. Turn off the engine and remove the ignition key. Let the engine/exhaust cool off if necessary. Disconnect the vehicle battery when working on the electrical system. Use appropriate tools and wear always safety glasses and hand protection. Have another person help you.

**MOUNTING:** All parts and connections removed from the vehicle must be reinstalled in accordance with the vehicle manufacturer specifications or replaced by parts and hardware delivered by SW-MOTECH.

**⚠ WARNING:** Secure all threads, unless otherwise specified, with medium-strong strength liquid thread locker. Torque specifications undefined by SW-MOTECH must be obtained from the vehicle manufacturer or by a certified motorcycle workshop!

**FUNCTION CHECK:** After installation also make sure that no moving parts are obstructed, and function of the vehicle is not hindered in any way. Cables and hoses must not rub and/or be pinched.

**⚠ WARNING:** Before starting to ride, perform a comprehensive check of all functions. After the first 50 km and then at regular intervals, check the tightening torque of all connections and the proper fit of the product. Installed accessories can change driving behavior/stability of the vehicle.

Konfektionierung durch / Packed by:

Datum der Konfektionierung / Date of packaging:



SW-MOTECH GmbH & Co. KG  
Ernteweg 7-10  
35282 Rauschenberg  
Germany

Tel. / phone + 49 (0)6425 / 8168 - 050  
Fax / fax + 49 (0)6425 / 8168 - 10  
info@sw-motech.com  
www.sw-motech.com

**STÜCKLISTE - ANBAUANLEITUNG LESEN UND AUFBEWAHREN / PARTS LIST - READ AND SAVE THESE MOUNTING INSTRUCTIONS**

Schritt Step	Nr. No.	Art.-Nr. / Bezeichnung <sup>a</sup> Item No. / Description <sup>a</sup>	Artikel	Part	Anzahl <sup>b</sup> Quantity <sup>b</sup>	N·m <sup>c</sup>
<b>3</b>	(1)	KFT.01.699.002L / R	Befestigungslasche; links / rechts	Mounting Tab; left / right	2 / 2	
	(2)	M8 x 30; DIN 912	Innensechskantschraube	Hexagon Socket Screw	4 / 4	20
	(3)	ø 8,4, DIN 125	Unterlegscheibe	Washer	4 / 8	
	(4)	Ø 20 / ø 8,4 / h 5	Distanzbuchse; schwarz; Höhe 5 mm	Spacer; black; height 5 mm	2 / 2	
<b>4</b>	(5)	KFT.01.841.001	Befestigungslasche	Mounting Tab	2 / 2	
	(6)	M8 x 50; DIN 912	Innensechskantschraube	Hexagon Socket Screw	4 / 4	20
	(7)	ø 8,4; DIN 125	Unterlegscheibe	Washer	4 / 8	
	(8)	Ø 16 / ø 8,4 / h 30	Distanzbuchse; Höhe 30 mm	Spacer; height 30 mm	4 / 4	
<b>5</b>	(9)	KFT.01.841.971.01 / 972.01	Seitenträger; links / rechts	Side Carrier; left / right	2 / 2	
	(10)	KFT.00.152.SV.6	Schnellverschlussatz mit Sicherungsscheiben	Quick Fastener Set with Lock Washers	1 / 1	
<b>7</b>	(11)	KFT.06.525.005	Querverbinder	Crossbar	1 / 1	
<b>8</b>	(12)	M6 x 55; DIN 912	Innensechskantschraube	Hexagon Socket Screw	2 / 2	8
	(13)	ø 6,4, DIN 125	Unterlegscheibe	Washer	2 / 2	
	(14)	Ø 18 / ø 6,4 / h 31	Distanzbuchse; Höhe 31 mm	Spacer; height 31 mm	2 / 2	
	(15)	ø 6,4; DIN 9021	Unterlegscheibe	Washer	2 / 2	
	(16)	M6; DIN 6927	Mutter mit Bund; selbstsichernd	Lock Nut with Flange	2 / 2	

8.8	Regelgewinde / Coarse Thread Ø						N·m	M4	M5	M6	M8	M10	M12	10.9	Regelgewinde / Coarse Thread Ø						N·m	M4	M5	M6	M8	M10	M12
	Stahl FK 8.8 / Steel CL 8.8														Stahl FK 10.9 / Steel CL 10.9												
	2,8	5,5	9,6	23	46	79	4,1	8,1	14	34	67	115															

Anmerkungen: <sup>a</sup> Alle Maßangaben in Millimeter. <sup>b</sup> Der zweite Wert gibt die Gesamtanzahl des jew. Artikels in der Lieferung an. <sup>c</sup> Keine Anzugsmomentvorgabe; Verwenden Sie das vom Fzg.-Hersteller definierte Anzugsmoment! Das Std.-Anzugsmoment der Tabelle kann verwendet werden, wenn es den Fzg.-Hersteller-Vorgaben entspricht.

Note: <sup>a</sup> All measurements in millimeters. <sup>b</sup> The second number indicates the total quantity of the part in the delivery. <sup>c</sup> No torque specifications: Use the torque defined by vehicle manufacturer! The standard torque in this table can be used as long as it is within the vehicle manufacturer's specifications.

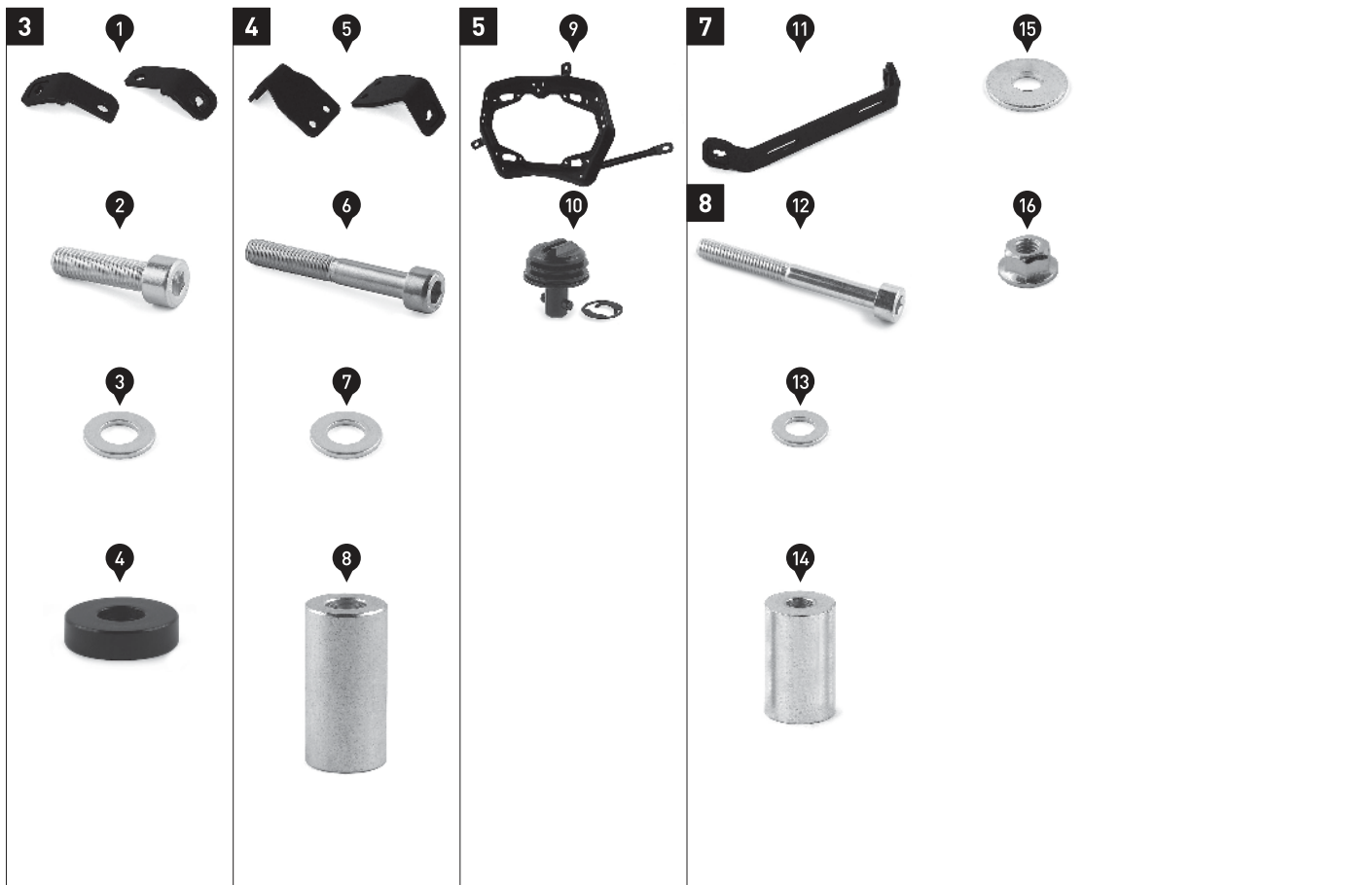

1

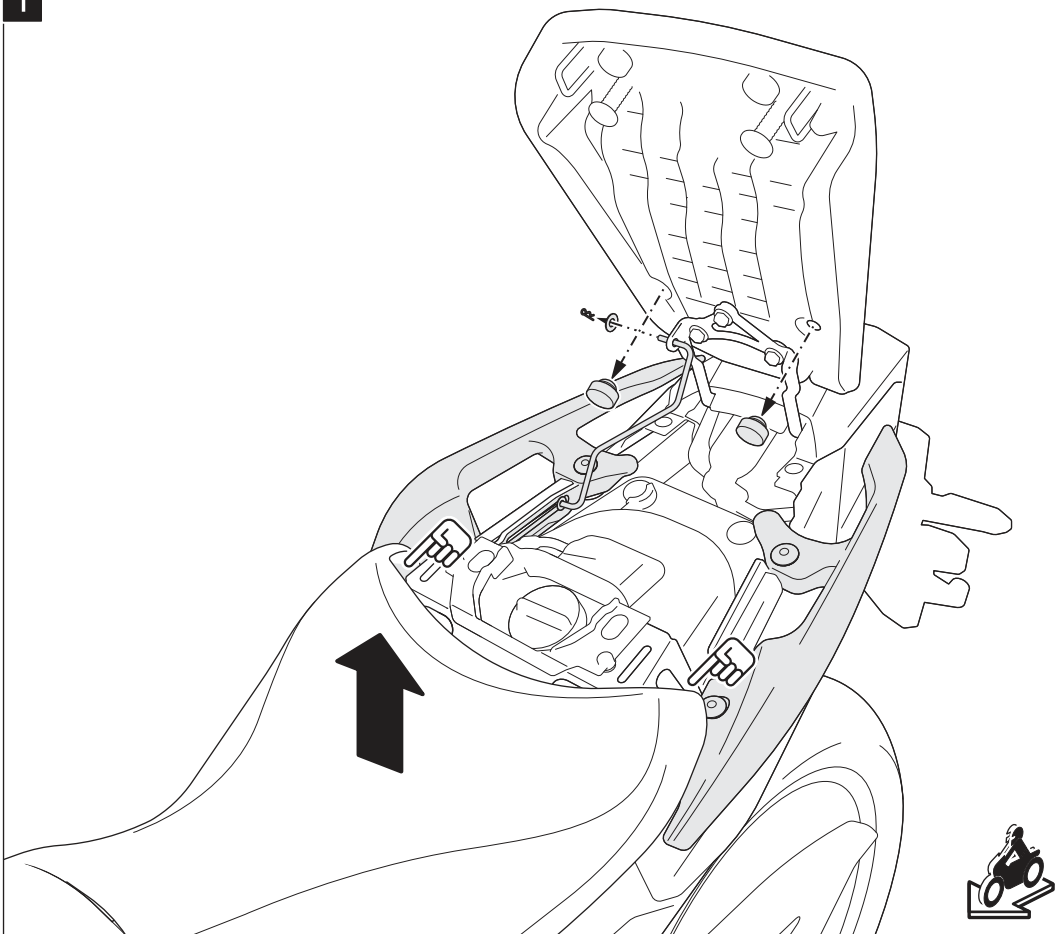

**⚠ WARNING: Tragen Sie immer Augen- und Handschutz!**

**⚠ WARNING: Verwenden Sie immer geeignetes Werkzeug!**

Öffnen Sie den Soziussitz. Entfernen Sie die gezeigten original Sitzbank-Gummis.

Lösen Sie den in der Zeichnung gezeigten Splint der Stütze. Lösen Sie die Stütze aus der oberen Verankerung. Stützen Sie den Soziussitz während der Montagearbeiten mit einem geeigneten Gegenstand ab.

Lösen Sie die markierten Schrauben der Sitzbank und entfernen Sie diese vom Fahrzeug.

**⚠ WARNING: Always wear eye and hand protection!**

**⚠ WARNING: Always use the appropriate tools!**

Open the passenger seat. Remove the original seat rubbers.

Loosen the splint of the support-staff shown in the drawing. Pull the support-staff out of the upper anchorage. Support the passenger seat with a suitable object during the mounting process.

Loosen the marked screws of the bench and remove it from the vehicle.



2

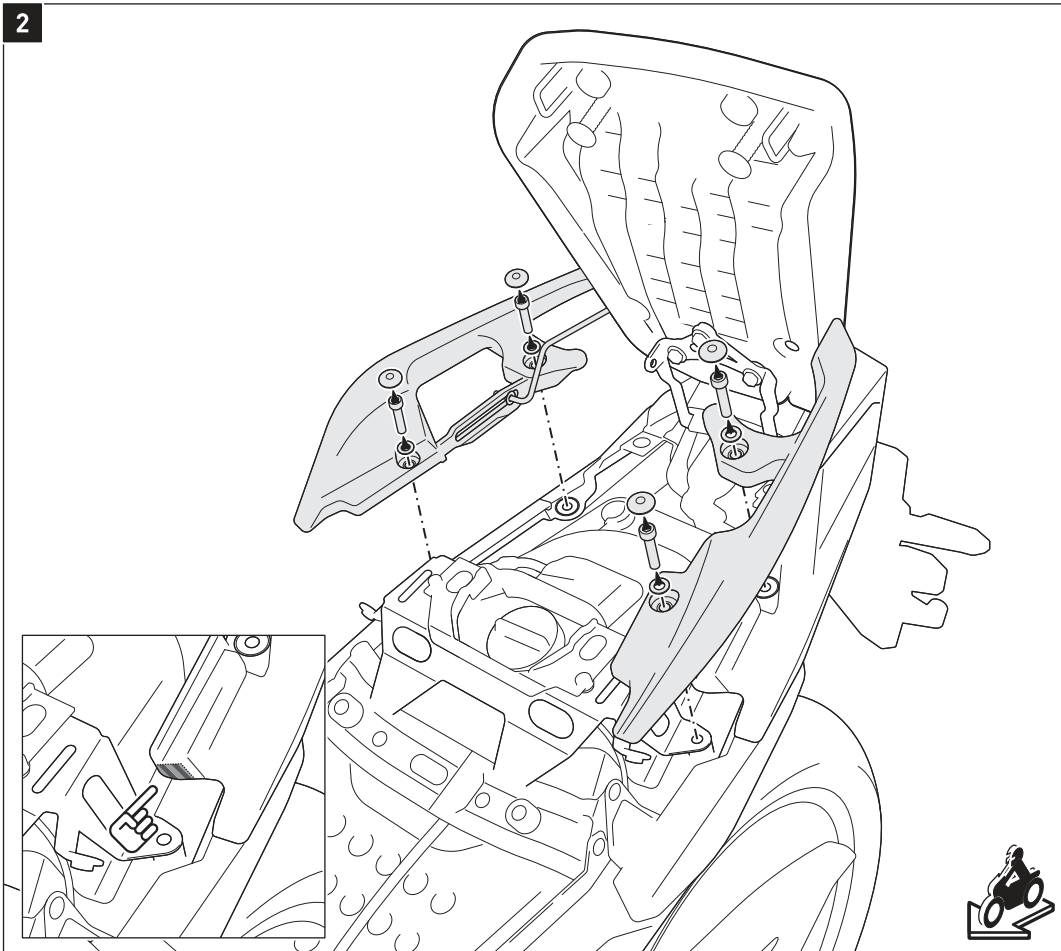

Entfernen Sie die Kunststoffkappen und die original Schrauben der Sozius-Haltegriffe.

Entfernen Sie anschließend vorsichtig die Sozius-Haltegriffe vom Fahrzeug.

**⚠ WARNING: Vor Wiedermontage der Sozius-Haltegriffe in Schritt [3] müssen beidseitig kleine Ausschnitte an den markierten Stellen der Heckverkleidungen vorgenommen werden, wie in der Detailzeichnung gezeigt.**

Remove the plastic caps and the original screws of the passenger grips.

Then remove the passenger grips carefully.

**⚠ WARNING: Before reassembling the passenger grips in step [3] it is necessary to create small cutouts in the tail panels, as shown in the detail drawing.**



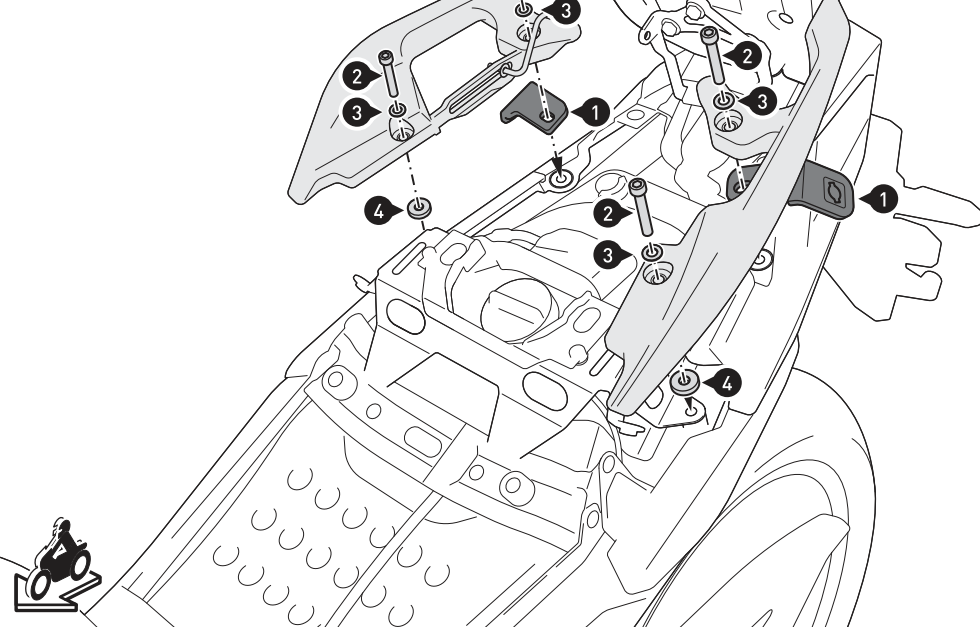

Verschrauben Sie die Befestigungslaschen (1) mit den Sozius-Haltegriffen am Fahrzeug, wie in der Zeichnung gezeigt. Halten Sie die Distanzbuchsen (4) mit etwas Fett in Position.

**⚠️ WARNUNG: Verwenden Sie flüssige Schraubensicherung!**  
Ziehen Sie die Schrauben noch nicht an.

**⚠️ HINWEIS:** Bei gleichzeitig montiertem SW-MOTECH Gepäckträger entfallen die Befestigungslaschen (1).

Verbinden Sie die Stütze wieder mit dem Soziussitz und verschrauben Sie anschließend die Sitzbank wieder am Fahrzeug.

Attach the mounting tabs (1) with the passenger grips to the vehicle, as shown in the drawing. Keep the spacers (4) with some grease in position.

**⚠️ WARNUNG: Use liquid thread locker!**  
Do not fully tighten the screws yet.

**⚠️ NOTICE:** If the SW-MOTECH luggage rack is mounted, the mounting tabs (1) are not required.

Reattach the support staff to the passenger seat, then reattach the bench to the vehicle.



**LT** Medium

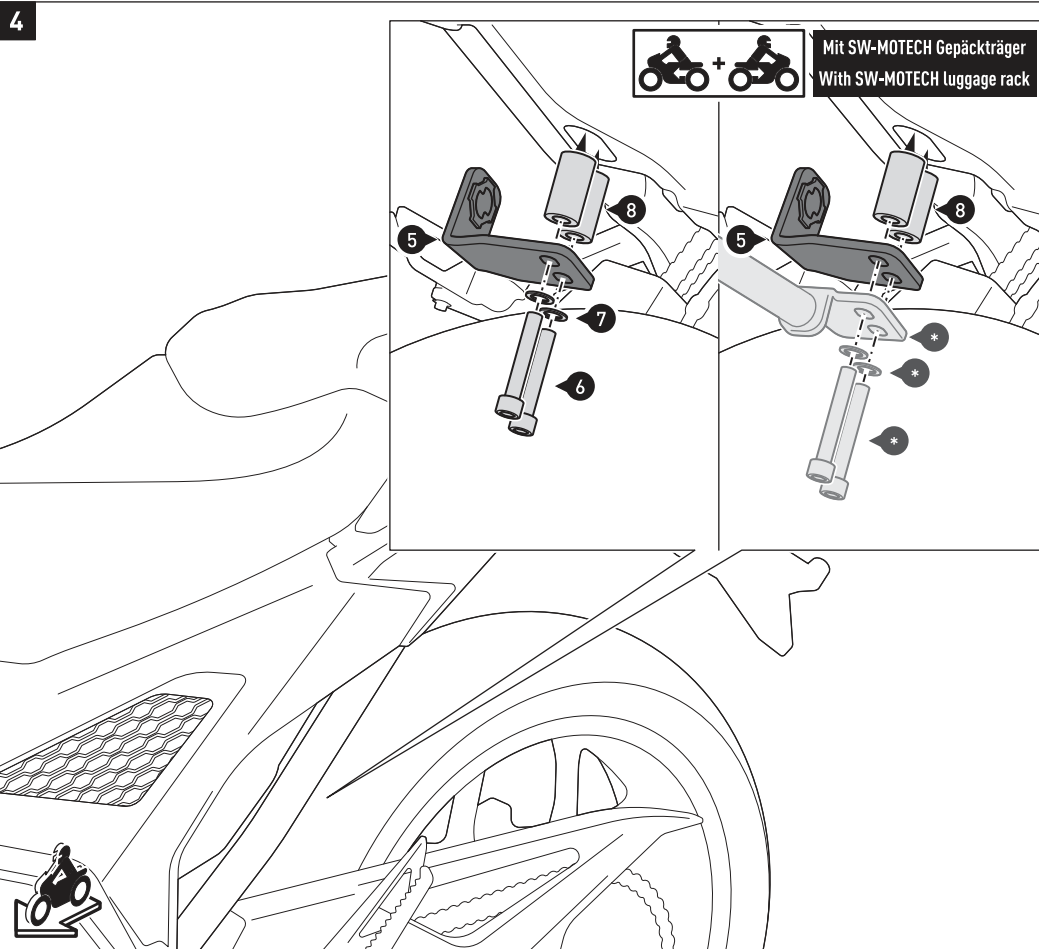

**⚠️ HINWEIS:** Bei gleichzeitig montiertem SW-MOTECH Gepäckträger entfallen die Schrauben (6) und Unterlegscheiben (7). Verwenden Sie stattdessen die Teile (\*) des Gepäckträgers. Montieren Sie die Haltestreben des Gepäckträgers zwischen den Befestigungslaschen (5) und Unterlegscheiben (\*).

Montieren Sie die Befestigungslaschen (5) beidseitig hinter den Sozius-Fußrasten, wie in der Detailzeichnung gezeigt.

**⚠️ WARNUNG: Verwenden Sie flüssige Schraubensicherung!**  
Ziehen Sie die Schrauben noch nicht an.

**⚠️ NOTICE:** If the SW-MOTECH luggage rack is mounted, the screws (6) and washers (7) are not required. Use the parts (\*) of the luggage rack instead. Mount the luggage rack's mounting struts between the mounting tabs (5) and washers (\*).

Attach the mounting tabs (5) behind both passenger footrests, as shown in the detail drawing.

**⚠️ WARNUNG: Use liquid thread locker!**  
Do not fully tighten the screws yet.



**LT** Medium



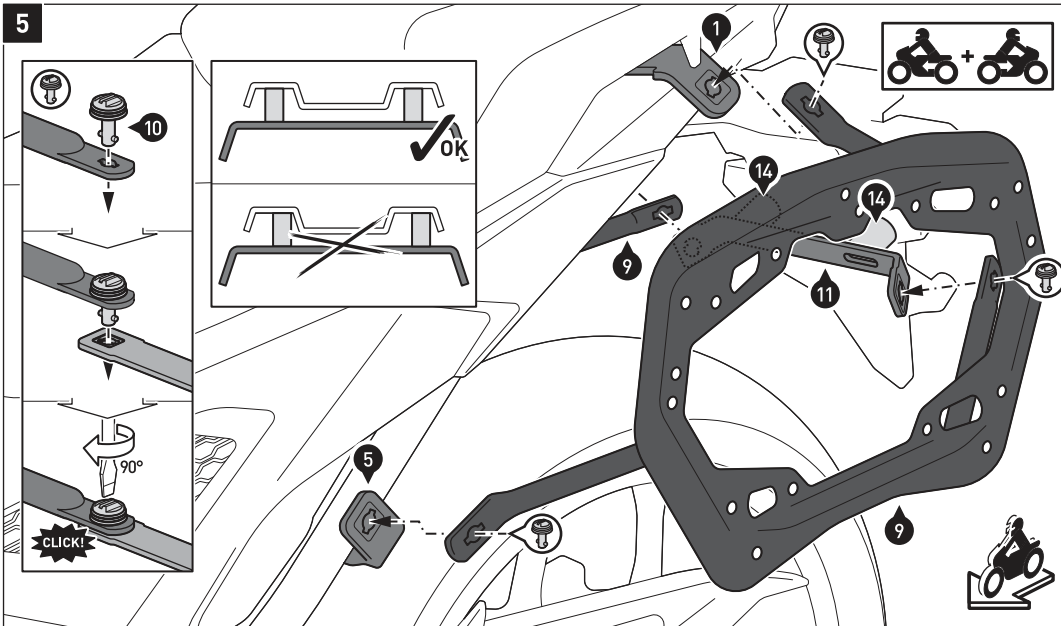

Verbinden Sie die beiden Kofferträger (9) mit den Befestigungslaschen (1) und (5); verwenden Sie die Schnellverschlüsse (10), wie in der Detailzeichnung gezeigt.

Verbinden Sie anschließend die hinteren Befestigungsausleger mit dem Querverbinder (11); verwenden Sie auch hier die Schnellverschlüsse (10). Positionieren Sie zuvor die Distanzbuchsen (14) zwischen Querverbinder (11) und Kennzeichenhalter. Richten Sie die Distanzbuchsen (14) gleichmäßig aus

Connect the side carriers (12) to the mounting tabs (2) and (7) by using the fasteners (13), as shown in the detail drawing.

Then connect the crossbar (11) to the side carriers by using the fasteners (10). Position the spacers (14) between the crossbar (11) and the license plate holder. Align the spacers (14) evenly.

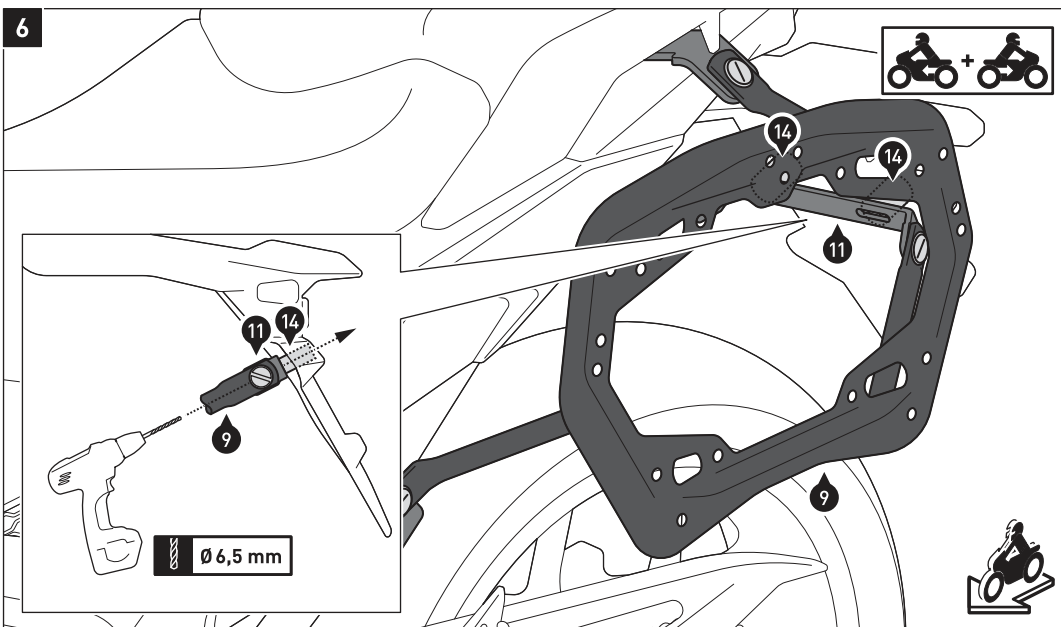

**⚠ HINWEIS:** Führen Sie die Schritte [6] und [7] nur durch, falls die Montagebohrungen des Kotflügels nicht mit dem Lochbild des Querverbinders (11) übereinstimmen.

**⚠ WARNUNG:** Bohren Sie mit einem 6,5-mm-Bohrer die Befestigungsbohrungen des Querverbinders (11). Nutzen Sie die Distanzbuchsen (14) als Führung. Entgraten Sie die Ränder der Bohrungen.

**⚠ NOTICE:** Follow step [6] and [7] only if the mounting holes of the mudguard do not match with the hole pattern of the crossbar (11).

**⚠ WARNING:** Use a 6.5-mm drillbit to drill the mounting holes for the crossbar (11). Use the spacers (14) for guidance. Deburr the edges.

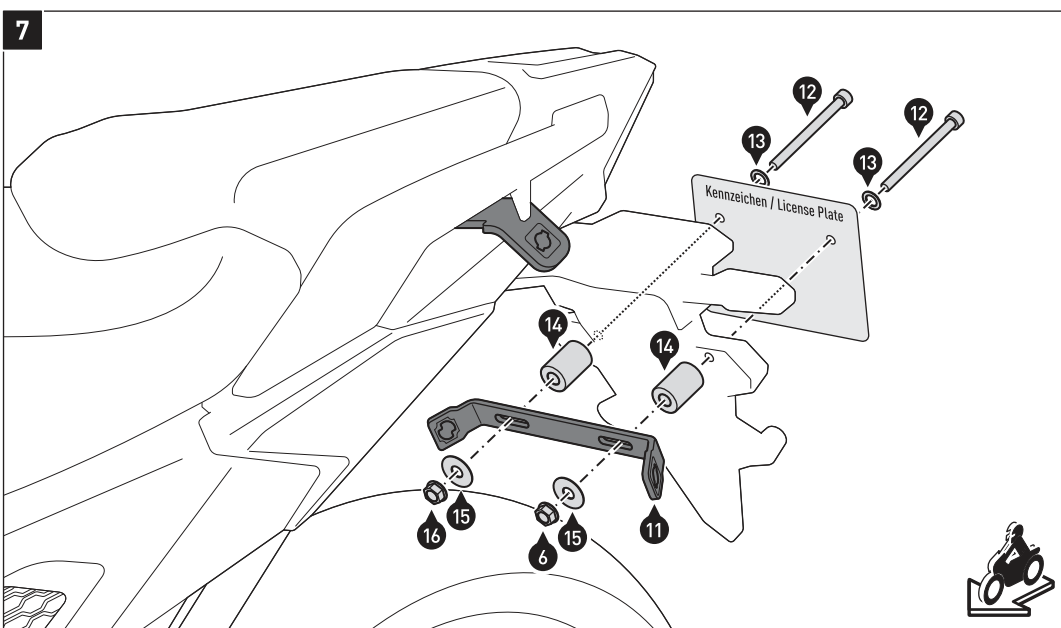

Verschrauben Sie den Querverbinder (14) am Kotflügel, wie in der Zeichnung gezeigt. Ziehen Sie die Schrauben noch nicht an.

Attach the crossbar (14) to the mudguard, as shown in the drawing. Do not fully tighten the screws yet.

8

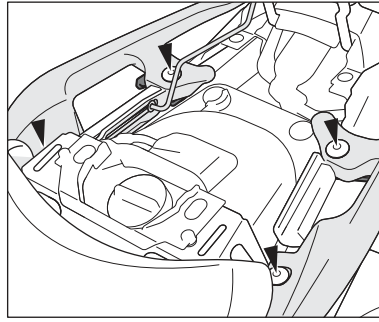
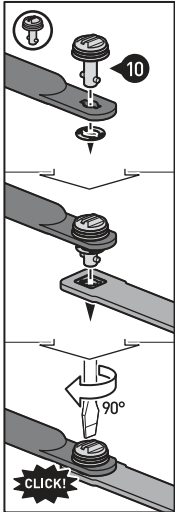

Verbinden Sie die Kofferträger (9) mit den Schnellverschlüssen (10) an den Befestigungslaschen (1) und (5) und dem Querverbinder (11). Sichern Sie die Schnellverschlüsse mit den Sicherungsscheiben.

Wenn alle Komponenten spannungsfrei sitzen, ziehen Sie die Schrauben wie vorgegeben an.

Setzen Sie abschließend die in Schritt [2] entfernten original Kunststoffkappen auf die Schrauben (2) auf.

**⚠ HINWEIS:** Die Diebstahlsicherung ist separat erhältlich.

Connect the side carriers (9) to the mounting brackets (1) and (5) and crossbar (11) with the fasteners (10). Secure the the fasteners with the lock washers.

Once all parts are evenly positioned without excess tension, tighten the screws as specified.

Finally plug the original plastic caps, removed in step [2] onto the screws (2).

**⚠ NOTICE:** The Anti-Theft Device is sold separately.

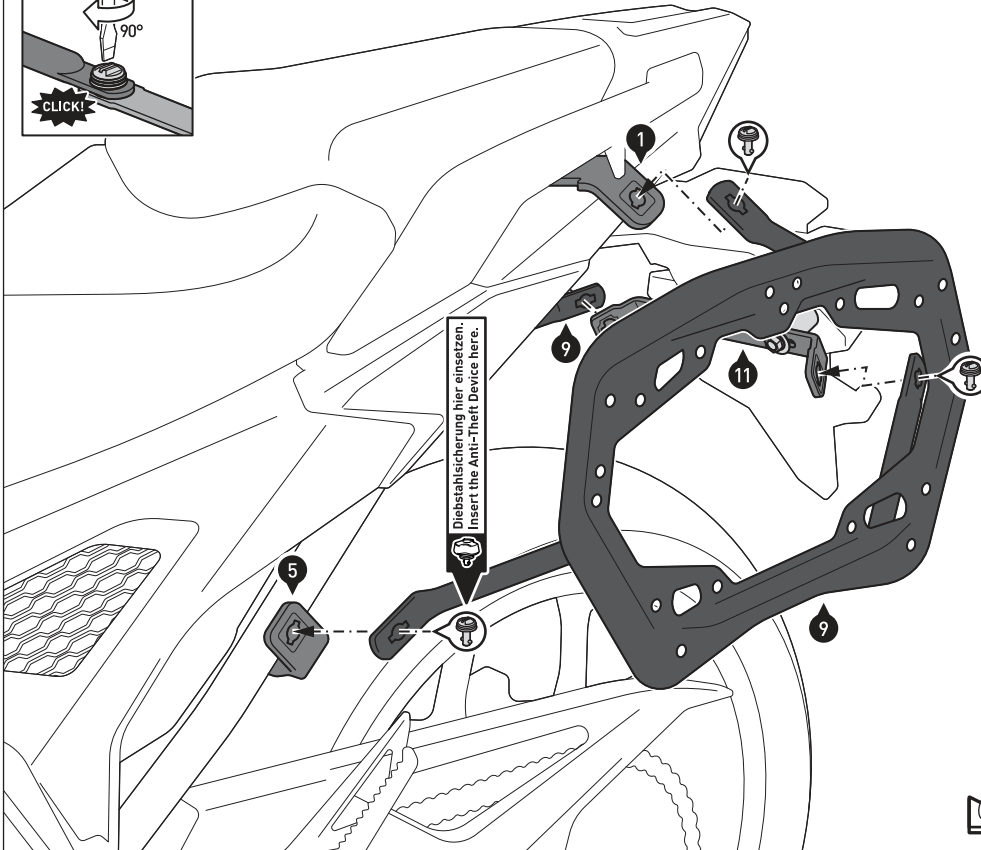

		20 N·m
		20 N·m
		8 N·m

PRODUKTSPEZIFISCHE HINWEISE

Maximale Zuladung	Höchstgeschwindigkeit
10 KG (22 lbs) /Seite	130 km/h (80 mph)

**⚠ WARNUNG:** Die angegebene maximale Zuladung beinhaltet das Gewicht von Koffer/Gepäck und Adapterkit! Es gilt die vom Fahrzeughersteller genannte, maximale Zuladung des Fahrzeugs!

**⚠ HINWEIS:** Die Seitenträger wurden ausschließlich für die Verwendung von SW-MOTECH Adapterkits konzipiert.

**⚠ HINWEIS:** Demontieren Sie die Seitenträger bei Fahrten ohne Gepäck. Benutzen Sie die Seitenträger immer paarweise.

**⚠ WARNUNG:** Achten Sie darauf, dass sich die Koffer nach Montage am Fahrzeug NICHT im Abgasstrom befinden! Verbrennungsgefahr!

**⚠ HINWEIS:** Beachten Sie die landesspezifischen Vorschriften für Zulassung/Betrieb Ihres Fahrzeugs bzw. anwendbare TÜV-Vorschriften. Lassen Sie eintragungspflichtige Teile nach Montage durch Ihre Prüfstelle in die Fahrzeugpapiere eintragen.

PRODUCT SPECIFIC INFORMATION

Maximum Load	Maximum Speed
10 KG (22 lbs) /side	130 km/h (80 mph)

**⚠ WARNING:** The indicated maximum load is inclusive the weight of case/luggage and adapter kit. The maximum vehicle load specified by the manufacturer must not be exceeded!

**⚠ NOTICE:** The side carriers are designed exclusively for the use of SW-MOTECH Adapter Kits.

**⚠ NOTICE:** Dismount the side carriers when travelling without cases/luggage. Always use the side carriers in pairs.

**⚠ WARNING:** Make sure that after attaching the luggage to the vehicle it is NOT in the exhaust flow! Dangers of burns!

**⚠ NOTICE:** Observe the country-specific regulations concerning vehicle registration/operation as well as TÜV regulations if applicable. If required, register installed parts in the vehicle documents through an appropriate inspection authority.

Item number: KFT.00.152.36000

Revision: 00 · Date: 08 - 2023

## Adapter kit for PRO side carrier

 ~ 0.25 h.

EASY      DIFFICULT

**ENGLISH** Thank you for choosing this premium product from SW-MOTECH. Visit our online shop for more information (e.g. model assignments). Required documents (e.g. national type approval) are available there for you to download.

Please read and understand all the instructions, safety information and warnings in these mounting instructions before mounting and using the product in order to avoid injury and damage. Keep these mounting instructions for reference.

This product was developed for vehicles in factory condition. Compatibility with original accessories or accessories from other manufacturers cannot be guaranteed.

These mounting instructions have been prepared to the best of our current knowledge. No legal claims relating to accuracy can be made. Errors and omissions excepted. We reserve the right to make technical and design changes. The copyright is held by SW-MOTECH.

### SAFETY WARNING SYMBOL

 This warning symbol is used in these mounting instructions to warn of deadly dangers, injuries or other hazards. The words DANGER, WARNING or CAUTION are used as part of this warning symbol to convey important safety messages and information relating to the installation and use of this product. These words, together with the safety warning symbol, mean:

 **DANGER:** Indicates a hazardous situation which, if not avoided, will result in death or serious injury!

 **WARNING:** Indicates a hazardous situation which, if not avoided, may result in death or serious injury!

 **CAUTION:** Indicates a hazardous situation which, if not avoided, may result in minor or moderate injury!

 **NOTE:** Important information, but not relating to a risk of death or injury (property damage only)!

### GENERAL INFORMATION

 **WARNING:** Assembly and/or maintenance of this product requires advanced technical skill, appropriate tools, and a good understanding of tool usage and torque specifications. For your own safety, SW-MOTECH recommends having the assembly and/or maintenance carried out by a qualified and certified motorcycle workshop.

 **WARNING:** If you do choose to assemble this product yourself, carefully and fully read the mounting instructions before assembly and use, and follow all instructions to avoid serious injury or death. Also observe all relevant information in the vehicle manual when mounting or using the product. IF YOU DO NOT UNDERSTAND ANY PART OF THESE MOUNTING INSTRUCTIONS OR NEED AN EXPLANATION AS TO A SPECIFIC INSTRUCTION, DO NOT ATTEMPT TO INSTALL THIS PRODUCT WITHOUT CONSULTING SW-MOTECH FOR ASSISTANCE!

**PREPARATION:** Read the mounting instructions carefully and make sure that all parts on the parts list are available.

 **CAUTION:** Ensure that your vehicle is standing securely. Switch off the engine and remove the ignition key. Allow the engine/exhaust to cool down if necessary. Disconnect the battery when working on the electrical system. Only use proper tools and always wear safety goggles and gloves during assembly and maintenance. Have a second person help you with assembly and maintenance.

**ASSEMBLY:** All parts and connections removed from the vehicle must be reinstalled according to the vehicle manufacturer's specifications or replaced with parts and hardware supplied by SW-MOTECH.

 **WARNING:** Secure all threads with a medium-strength liquid threadlocker, unless otherwise specified.

 **DANGER:** Tightening torques not defined by SW-MOTECH must be obtained from the vehicle manufacturer or a certified motorbike workshop.



**FUNCTIONAL CHECK:** After mounting the product, ensure that no moving parts are obstructed and that the function of the vehicle is not impeded. Cables and hoses must not rub against each other and/or be hindered in any way.

 **WARNING:** Carry out a comprehensive functionality check before you start to drive. Check the tightening torque of all connections and the tight fit of the product after the first 50 km and then at regular intervals. Mounted accessories can change the handling and stability of the vehicle.



SW-MOTECH GmbH & Co. KG  
Ernteweg 7-10  
35282 Rauschenberg  
Germany



 [info@sw-motech.com](mailto:info@sw-motech.com)  
 [www.sw-motech.com](http://www.sw-motech.com)



## LEGEND OVERVIEW - READ AND KEEP MOUNTING INSTRUCTIONS!



Take note of the symbols and what they mean in the ASSEMBLY section. If the term OEM appears in the ASSEMBLY section, the vehicle manufacturer's specifications must be observed and applied.



If you have any questions, please don't hesitate to contact our Customer Service team or our distributors. You can find our telephone number and a list of our distributors in our online shop:

**[www.sw-motech.com](http://www.sw-motech.com)**



**Do not use thread lock:** Indicates that no liquid thread lock should be used at this point.















**Tighten/note the tightening torque information:**

Indicates the tightening torque of a part specified by SW-MOTECH or the vehicle manufacturer (OEM).



**Use thread locker:** Indicates that a thread must be coated with liquid thread locker. H (HIGH): high strength; M (MEDIUM): medium strength; L (LOW): low strength.

**PARTS LIST - READ AND KEEP MOUNTING INSTRUCTIONS!**

<p><b>1</b></p> 	<p><b>2</b></p> 	<p><b>3</b></p> 	<p><b>4</b></p> 	<p><b>5</b></p> 	<p><b>6</b></p> 
<p>HSK.00.745.025.35GR</p> <p> <b>2/2</b></p>	<p>M6 x 12; ISO 7380 SC.ST.06.012.02.7380.109</p> <p> <b>4/4</b></p>	<p>GPT.00.152.010.35</p> <p> <b>4/4</b></p>	<p>M6 x 25; DIN 7991 SC.ST.06.025.02.7991.088</p> <p> <b>4/4</b></p>	<p>M6; DIN 6927 MU.ST.06.02.6927.08</p> <p> <b>4/4</b></p>	<p>KFT.00.152.026.02</p> <p> <b>8/8</b></p>

1

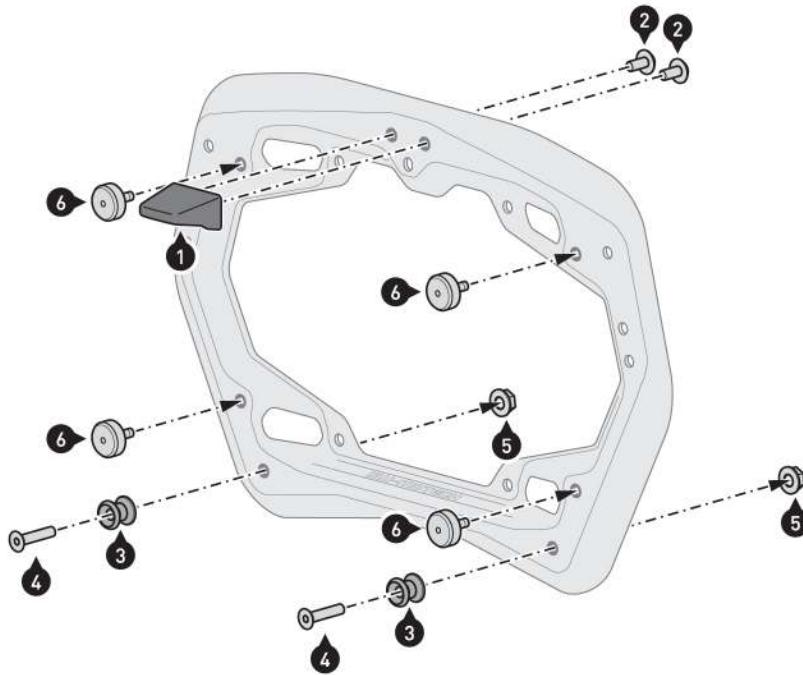

**⚠ WARNING: Always wear eye and hand protection!**  
**⚠ WARNING: Always use the proper tools!**

**⚠ NOTE:** The illustration shows how to mount on the right PRO side carrier. Follow the same steps with the left PRO side carrier as with the right PRO side carrier.

Screw the parts indicated to your PRO side carriers (sold separately).

**⚠ ATTENTION: Use liquid thread locker (screws 2) only!**  
 Tighten the screws as specified in the mounting instructions.

Then insert the rubber dampeners (6) into the indicated openings.

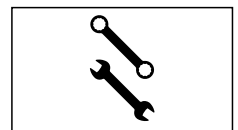
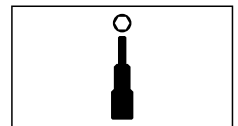
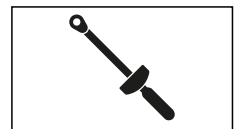
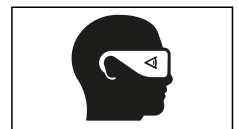

**PRODUCT-SPECIFIC NOTES**

**⚠ NOTE:** *Observe the country-specific regulations for the registration/operation of your vehicle or applicable TÜV regulations. After assembly, have parts that are subject to registration entered in the vehicle documents by your test centre.*

Item number: **HSK.00.745.11000/B**

Revision: **03** · Date: **09 - 2023**

## DUSC L

 ~ 0.25 h.

EASY      DIFFICULT

**ENGLISH** Thank you for choosing this premium product from SW-MOTECH. Visit our online shop for more information (e.g. model assignments). Required documents (e.g. national type approval) are available there for you to download.

**Please read and understand all the instructions, safety information and warnings in these mounting instructions before mounting and using the product in order to avoid injury and damage. Keep these mounting instructions for reference.**

**This product was developed for vehicles in factory condition. Compatibility with original accessories or accessories from other manufacturers cannot be guaranteed.**

**These mounting instructions have been prepared to the best of our current knowledge. No legal claims relating to accuracy can be made. Errors and omissions excepted. We reserve the right to make technical and design changes. The copyright is held by SW-MOTECH.**

### SAFETY WARNING SYMBOL

 This warning symbol is used in these mounting instructions to warn of deadly dangers, injuries or other hazards. The words **DANGER**, **WARNING** or **CAUTION** are used as part of this warning symbol to convey important safety messages and information relating to the installation and use of this product. These words, together with the safety warning symbol, mean:

 **DANGER:** Indicates a hazardous situation which, if not avoided, will result in death or serious injury!

 **WARNING:** Indicates a hazardous situation which, if not avoided, may result in death or serious injury!

 **CAUTION:** Indicates a hazardous situation which, if not avoided, may result in minor or moderate injury!

 **NOTE:** Important information, but not relating to a risk of death or injury (property damage only)!

### GENERAL INFORMATION

 **WARNING:** Assembly and/or maintenance of this product requires advanced technical skill, appropriate tools, and a good understanding of tool usage and torque specifications. For your own safety, SW-MOTECH recommends having the assembly and/or maintenance carried out by a qualified and certified motorcycle workshop.

 **WARNING:** If you do choose to assemble this product yourself, carefully and fully read the mounting instructions before assembly and use, and follow all instructions to avoid serious injury or death. Also observe all relevant information in the vehicle manual when mounting or using the product. **IF YOU DO NOT UNDERSTAND ANY PART OF THESE MOUNTING INSTRUCTIONS OR NEED AN EXPLANATION AS TO A SPECIFIC INSTRUCTION, DO NOT ATTEMPT TO INSTALL THIS PRODUCT WITHOUT CONSULTING SW-MOTECH FOR ASSISTANCE!**

**PREPARATION:** Read the mounting instructions carefully and make sure that all parts on the parts list are available.

 **CAUTION:** Ensure that your vehicle is standing securely. Switch off the engine and remove the ignition key. Allow the engine/exhaust to cool down if necessary. Disconnect the battery when working on the electrical system. Only use proper tools and always wear safety goggles and gloves during assembly and maintenance. Have a second person help you with assembly and maintenance.

**ASSEMBLY:** All parts and connections removed from the vehicle must be reinstalled according to the vehicle manufacturer's specifications or replaced with parts and hardware supplied by SW-MOTECH.

 **WARNING:** Secure all threads with a medium-strength liquid threadlocker, unless otherwise specified.

 **DANGER:** Tightening torques not defined by SW-MOTECH must be obtained from the vehicle manufacturer or a certified motorbike workshop.

**FUNCTIONAL CHECK:** After mounting the product, ensure that no moving parts are obstructed and that the function of the vehicle is not impeded. Cables and hoses must not rub against each other and/or be hindered in any way.

 **WARNING:** Carry out a comprehensive functionality check before you start to drive. Check the tightening torque of all connections and the tight fit of the product after the first 50 km and then at regular intervals. Mounted accessories can change the handling and stability of the vehicle.



SW-MOTECH GmbH & Co. KG  
Ernteweg 7-10  
35282 Rauschenberg  
Germany



 [info@sw-motech.com](mailto:info@sw-motech.com)  
 [www.sw-motech.com](http://www.sw-motech.com)



**LEGEND OVERVIEW - READ AND KEEP MOUNTING INSTRUCTIONS!**



Take note of the symbols and what they mean in the ASSEMBLY section. If the term OEM appears in the ASSEMBLY section, the vehicle manufacturer's specifications must be observed and applied.



If you have any questions, please don't hesitate to contact our Customer Service team or our distributors. You can find our telephone number and a list of our distributors in our online shop:  
**[www.sw-motech.com](http://www.sw-motech.com)**



**Do not use thread lock:** Indicates that no liquid thread lock should be used at this point.



**Tighten by hand:** Indicates that the attachment must be carefully tightened by hand.

**PARTS LIST - READ AND KEEP MOUNTING INSTRUCTIONS!**

**1**

**1**



HSK.00.745.80000/B

 **1/1**

**2**

**2**



HSK.00.745.027.02

 **2/2**

**3**

**3**



HSK.00.745.047.02

 **1/1**

**4**



4 x 10; WN 1452  
SC.ST.040.010.48.1452.109

 **2/2**

**5**



T20  
TRX.T20

 **1/1**



- ⚠ **WARNING: Always wear eye and hand protection!**
- ⚠ **WARNING: Always use the proper tools!**

**Opening the lid**

- 1.1** - Press the DUSC release button (1) and pull the lid latch buckle to the open position.
- 1.2** - Remove the latch buckle from the corresponding bracket and open the lid.



2

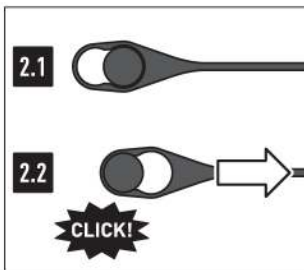
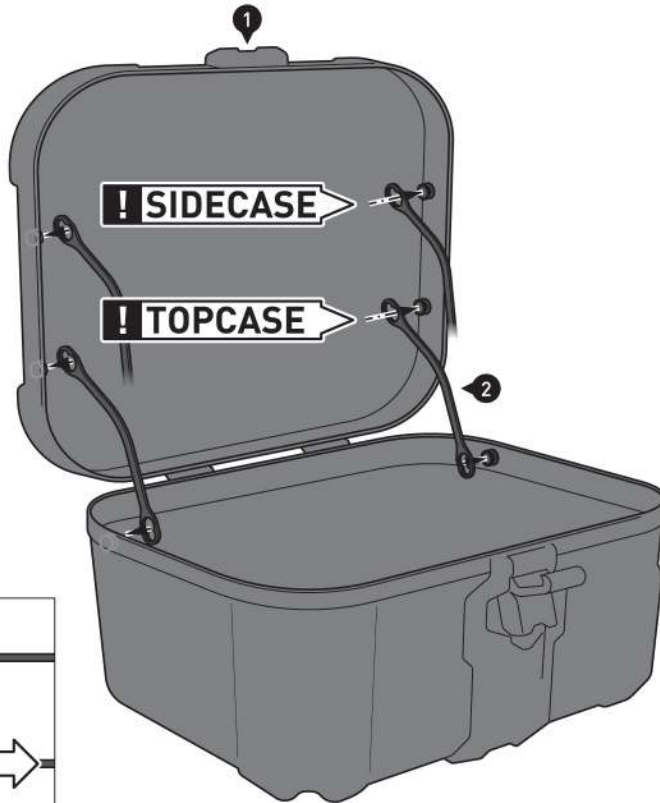

**Installing the lid limiter**

2.1 - Place the lid limiters (2) with the large openings on the mushroom-shaped supports provided

**⚠ NOTE:** Pay attention to the proper use of the DUSC (1): **top case** or **side case**. Fasten the lid limiters (2) to the respective mushroom-shaped DUSC (1).

2.2 - Pull the lid limiters (2) into fixed position.

**⚠ NOTE:** Before closing the lid for the first time, the lid limiters (2) must be slightly compressed. When closing the lid, make sure that the lid limiters (2) are not trapped between the lid and the case body.

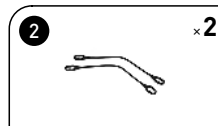

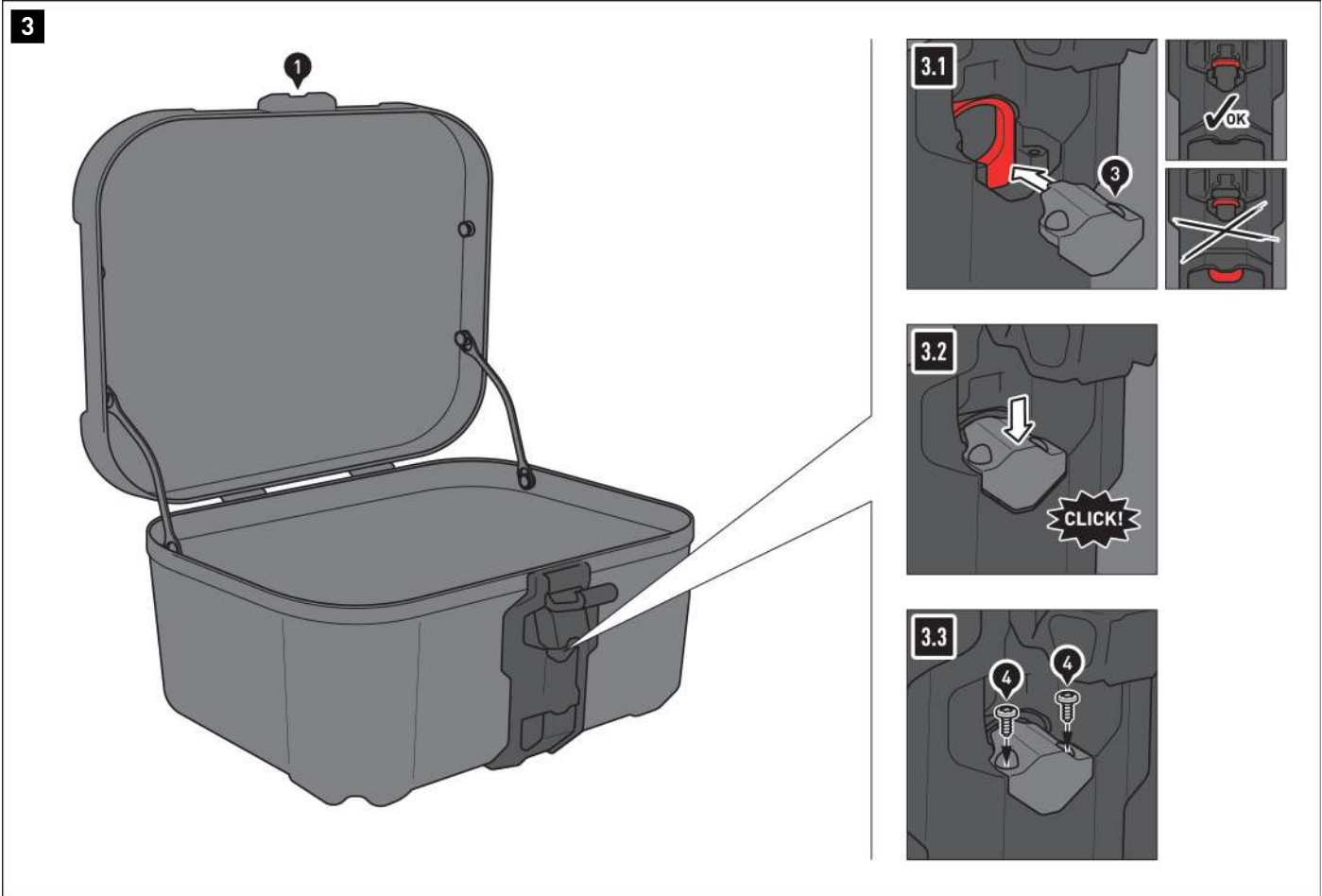

**Installing lock casing connector**

**⚠ NOTE:** If you have opted for the DUSC lock set, this step is not necessary. Install the lock set instead.

**3.1 -** Open the DUSC latch buckle (1) and position the latch housing connector (3) as shown.

**⚠ NOTE:** Make sure the locking tab is in the unlocked (up) position. If necessary, the locking tab must be pushed up into the unlocked position.

**3.2 -** Push the latch housing connector (3) down until it clicks into place.

**3.3 -** Screw in the latch housing connector (3) using the screws (4) and the torx key (5). Carefully tighten the screws by hand.

**⚠ WARNING:** Over-tightening the screws may damage the lock casing!

**⚠ NOTE:** Ensure that the locking mechanism is in working order!

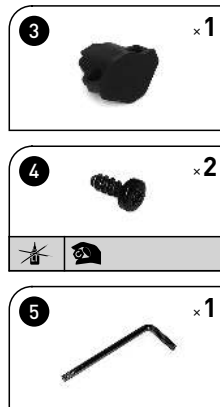



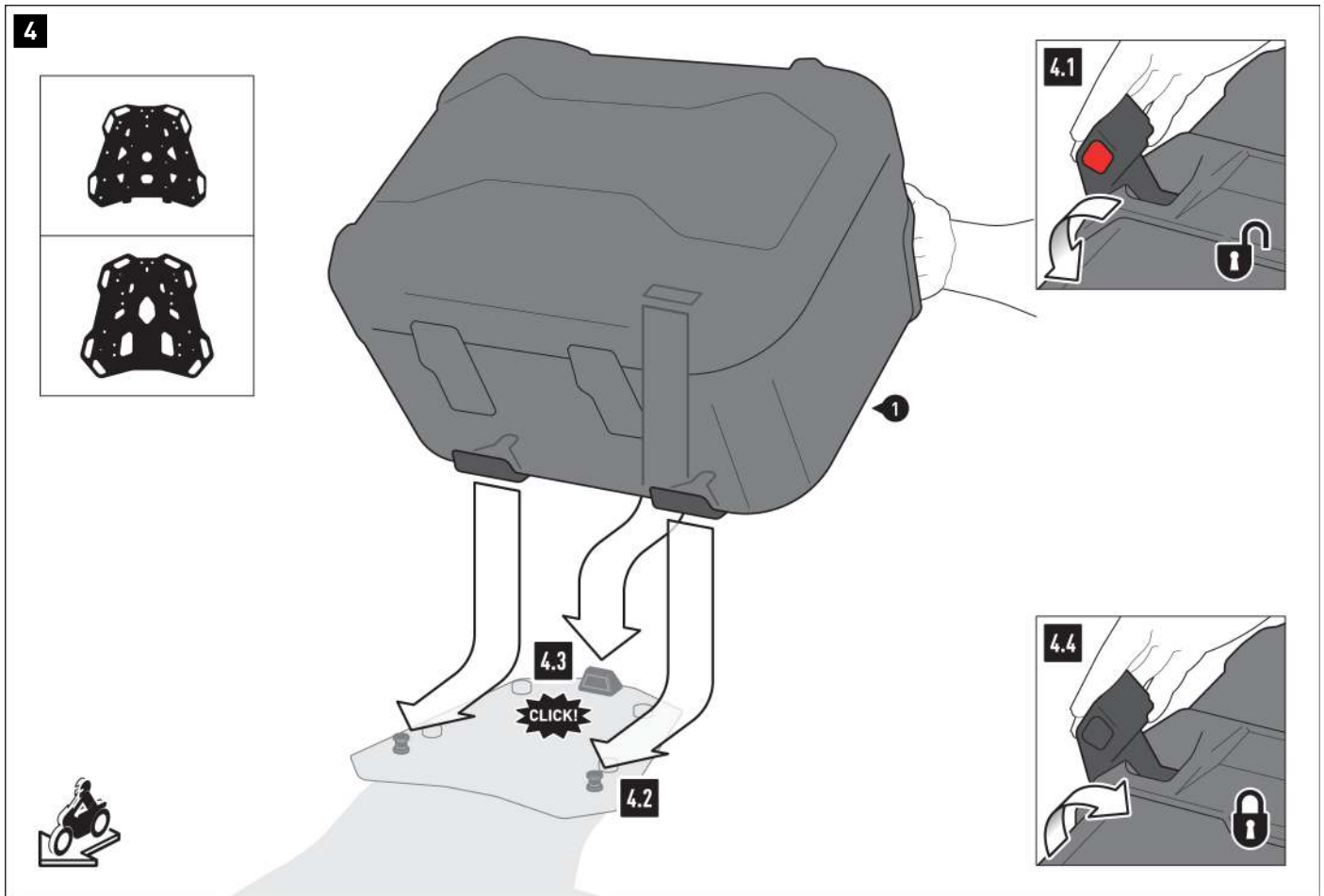

**Attaching the DUSC to a top case**

**4.1** - Press the DUSC release button (1) and pull the fastening system latch buckle to the open position.

**4.2** - Press the DUSC (1) with the two locking openings onto the mushroom-shaped supports of your SW-MOTECH rack.

**4.3** - Press the DUSC (1) with the locking opening onto the locking lug of your SW-MOTECH rack.

**▲ WARNING: You should be able to hear a clicking sound!**

**4.4** - Press the system latch buckle to closed position.

**▲ WARNING: Ensure the DUSC is firmly positioned!**

**▲ WARNING: Make sure that no components of the DUSC (1) can come into contact with any hot and moving parts on the vehicle!**

**Also ensure that all components are at least 5 cm away from hot parts as well as hot gas coming from the exhaust!**

**After assembly, make sure that this distance is maintained in all vehicle positions!**

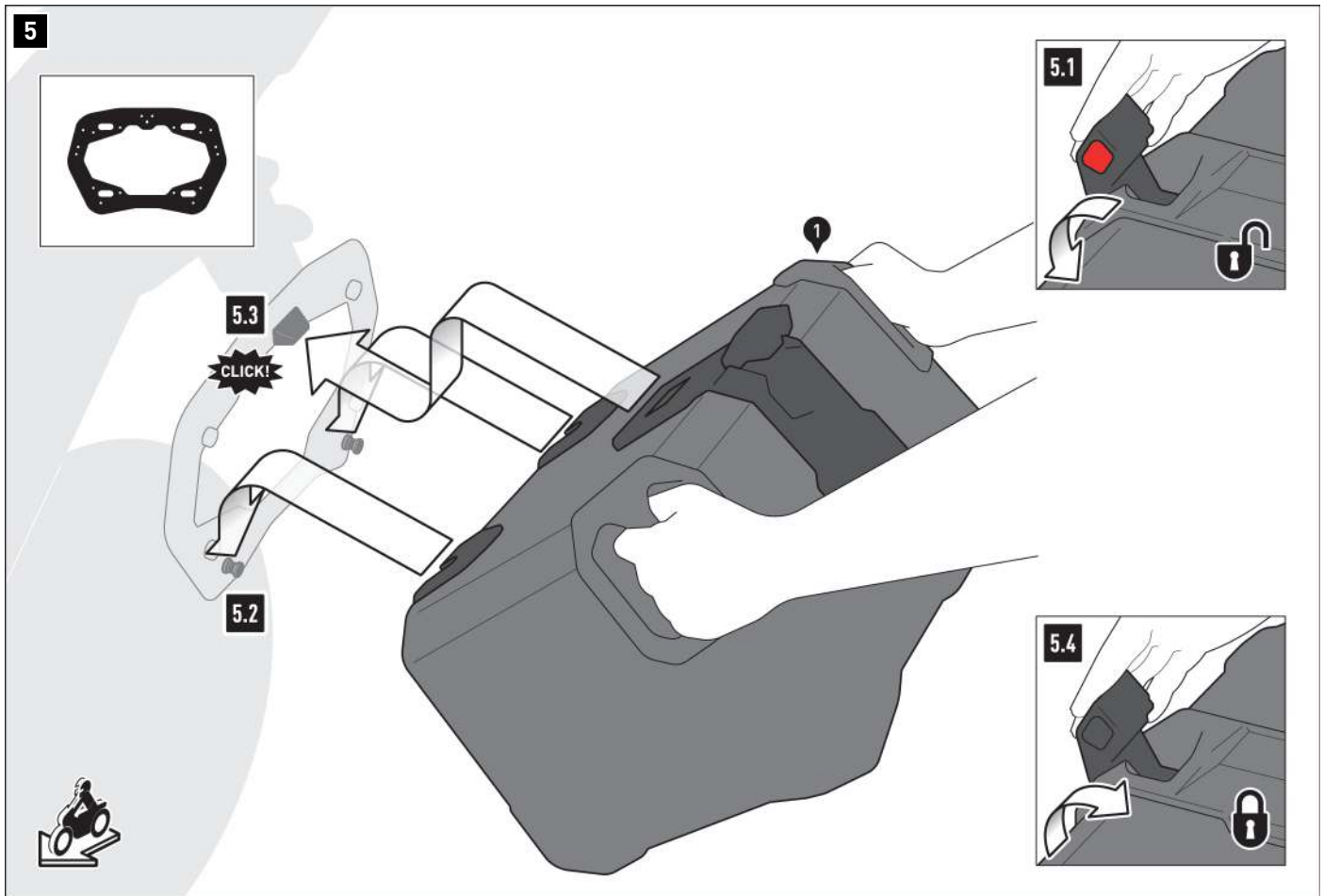

**Attaching the DUSC to a side case**

**5.1** - Press the DUSC release button (1) and pull the system latch buckle to the open position.

**5.2** - Press the DUSC (1) with the two locking openings onto the mushroom-shaped supports of your SW-MOTECH side carrier.

**5.3** - Press the DUSC (1) with the locking opening onto the locking lug of your SW-MOTECH side carrier.

**▲ WARNING: You should be able to hear a clicking sound!**

**5.4** - Press the system latch buckle to closed position.

**▲ WARNING: Ensure the DUSC is firmly positioned!**

**▲ WARNING: Make sure that no components of the DUSC (1) can come into contact with any hot and moving parts on the vehicle!**

**Also ensure that all components are at least 5 cm away from hot parts as well as hot gas coming from the exhaust!**

**After assembly, make sure that this distance is maintained in all vehicle positions!**

6



**Loading**

**▲ WARNING: Ensure that the load is evenly distributed! Ensure that the load will not slip while driving!**

**▲ NOTE:** Make sure never to store sharp-edged, pointed or similar objects that could cause personal injury or damage to the vehicle/DUSC! Be particularly careful not to damage the overpressure membrane built into the lid!

**Care**

Use ONLY a soft textile brush, cloth or sponge and warm soapy water for cleaning! Then rinse with clean water.

Do NOT use any harsh cleaning agents, utensils or pressure washer! Be sure to clean the DUSC after winter driving to avoid salt damage.

**▲ NOTE:** Surface materials may be subject to fluctuations in color (fading) in the event of prolonged and intensive exposure to sunlight and the elements (e.g. smog, acid rain, etc.)! SW-MOTECH is not responsible for this type of wear!

PRODUCT-SPECIFIC NOTES

**⚠ NOTE:** Observe the country-specific regulations for registering/operating your vehicle or the applicable TÜV regulations. After assembly, have parts that are subject to registration entered in the vehicle documents by your test centre.

**⚠ DANGER:** Carry out a comprehensive function check before driving!

**⚠ DANGER:** Check that the product is properly positioned before departure and at every rest stop (every 200 km)!

**⚠ DANGER:** The driving/braking behavior of the motorcycle changes noticeably after the attachment of this product!

**⚠ DANGER:** Lean angle and ground clearance may be restricted by this product!

**⚠ DANGER:** The maximum vehicle load specified by the vehicle manufacturer is applicable

Use as a top case:

 ≤ 5 kg (≤ 11 lbs)	 ≤ 130km/h (≤ 80mph)
---	---

Use as a side case:

 ≤ 10KG (≤ 22 lbs)	 ≤ 130km/h (≤ 80mph)
---	---

Item number: **LOC.00.745.10200**

Revision: **00** · Date: **08 - 2023**

## Hard case lock set

 ~ 0.25 h.

EASY      DIFFICULT

**ENGLISH** Thank you for choosing this premium product from SW-MOTECH. Visit our online shop for more information (e.g. model assignments). Required documents (e.g. national type approval) are available there for you to download.

Please read and understand all the instructions, safety information and warnings in these mounting instructions before mounting and using the product in order to avoid injury and damage. Keep these mounting instructions for reference.

This product was developed for vehicles in factory condition. Compatibility with original accessories or accessories from other manufacturers cannot be guaranteed.

These mounting instructions have been prepared to the best of our current knowledge. No legal claims relating to accuracy can be made. Errors and omissions excepted. We reserve the right to make technical and design changes. The copyright is held by SW-MOTECH.

### SAFETY WARNING SYMBOL

 This warning symbol is used in these mounting instructions to warn of deadly dangers, injuries or other hazards. The words **DANGER**, **WARNING** or **CAUTION** are used as part of this warning symbol to convey important safety messages and information relating to the installation and use of this product. These words, together with the safety warning symbol, mean:

 **DANGER:** Indicates a hazardous situation which, if not avoided, will result in death or serious injury!

 **WARNING:** Indicates a hazardous situation which, if not avoided, may result in death or serious injury!

 **CAUTION:** Indicates a hazardous situation which, if not avoided, may result in minor or moderate injury!

 **NOTE:** Important information, but not relating to a risk of death or injury (property damage only)!

### GENERAL INFORMATION

 **WARNING:** Assembly and/or maintenance of this product requires advanced technical skill, appropriate tools, and a good understanding of tool usage and torque specifications. For your own safety, SW-MOTECH recommends having the assembly and/or maintenance carried out by a qualified and certified motorcycle workshop.

 **WARNING:** If you do choose to assemble this product yourself, carefully and fully read the mounting instructions before assembly and use, and follow all instructions to avoid serious injury or death. Also observe all relevant information in the vehicle manual when mounting or using the product. IF YOU DO NOT UNDERSTAND ANY PART OF THESE MOUNTING INSTRUCTIONS OR NEED AN EXPLANATION AS TO A SPECIFIC INSTRUCTION, DO NOT ATTEMPT TO INSTALL THIS PRODUCT WITHOUT CONSULTING SW-MOTECH FOR ASSISTANCE!

**PREPARATION:** Read the mounting instructions carefully and make sure that all parts on the parts list are available.

 **CAUTION:** Ensure that your vehicle is standing securely. Switch off the engine and remove the ignition key. Allow the engine/exhaust to cool down if necessary. Disconnect the battery when working on the electrical system. Only use proper tools and always wear safety goggles and gloves during assembly and maintenance. Have a second person help you with assembly and maintenance.

**ASSEMBLY:** All parts and connections removed from the vehicle must be reinstalled according to the vehicle manufacturer's specifications or replaced with parts and hardware supplied by SW-MOTECH.

 **WARNING:** Secure all threads with a medium-strength liquid threadlocker, unless otherwise specified.

 **DANGER:** Tightening torques not defined by SW-MOTECH must be obtained from the vehicle manufacturer or a certified motorbike workshop.

**FUNCTIONAL CHECK:** After mounting the product, ensure that no moving parts are obstructed and that the function of the vehicle is not impeded. Cables and hoses must not rub against each other and/or be hindered in any way.

 **WARNING:** Carry out a comprehensive functionality check before you start to drive. Check the tightening torque of all connections and the tight fit of the product after the first 50 km and then at regular intervals. Mounted accessories can change the handling and stability of the vehicle.



SW-MOTECH GmbH & Co. KG  
Ernteweg 7-10  
35282 Rauschenberg  
Germany



 [info@sw-motech.com](mailto:info@sw-motech.com)  
 [www.sw-motech.com](http://www.sw-motech.com)





Take note of the symbols and what they mean in the ASSEMBLY section. If the term OEM appears in the ASSEMBLY section, the vehicle manufacturer's specifications must be observed and applied.



If you have any questions, please don't hesitate to contact our Customer Service team or our distributors. You can find our telephone number and a list of our distributors in our online shop:

**[www.sw-motech.com](http://www.sw-motech.com)**

**PARTS LIST - READ AND KEEP MOUNTING INSTRUCTIONS!**

**2**

**1**



HSK.00.745.500.04

 **3/3**

**2**



T20  
TRX.T20

 **1/1**

**3**



ALK.00.165.A63

 **2/2**

**3**

**3**



ALK.00.165.562.01

 **1/1**

**4**

**5**



QLS.00.095.520.01

 **2/2**

**6**



SV.ST.095.007.LK.02

 **2/2**



- ⚠ **WARNING: Always wear eye and hand protection!**
- ⚠ **WARNING: Always use the proper tools!**

**Opening the lid**

1.1 - Press the DUSC release button (\*) and pull the lid latch buckle into the open position.

1.2 - Remove the latch buckle from the corresponding bracket and open the lid.



2

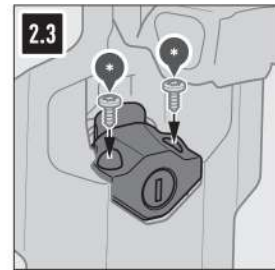
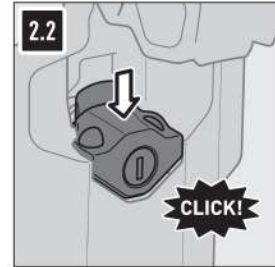
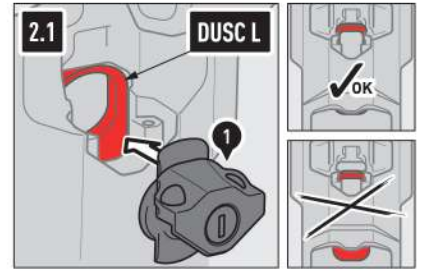

**Install DUSC lock**

**2.1** - Open the DUSC (\*) latch buckle and position the lock (1) as shown.  
 ⚠ **NOTE: DUSC L ONLY:** Make sure the locking tab (highlighted in red) is in the unlocked position (up)! If necessary, the locking tab must be pushed up into the unlocked position!

**2.2** - Push the lock (1) down until it clicks into place.

**2.3** - Screw in the lock (1) using the screws (\*) supplied with the DUSC and the torx key (2). Carefully tighten the screws by hand.

⚠ **WARNING: Over-tightening the screws may damage the lock casing!**

⚠ **NOTE:** Ensure that the locking mechanism is in working order!

⚠ **NOTE:** NEVER lubricate the lock cylinder with oil! Only use graphite powder!



3



#### Install toolbox lock

**3.1** - Insert the lock (4) with the sealing ring (\*) supplied with the toolbox in the lock hole of the cover. Secure the lock (4) on the inside with the safety clip (4)



**⚠ NOTE:** NEVER lubricate the lock cylinder with oil! Only use graphite powder!

4

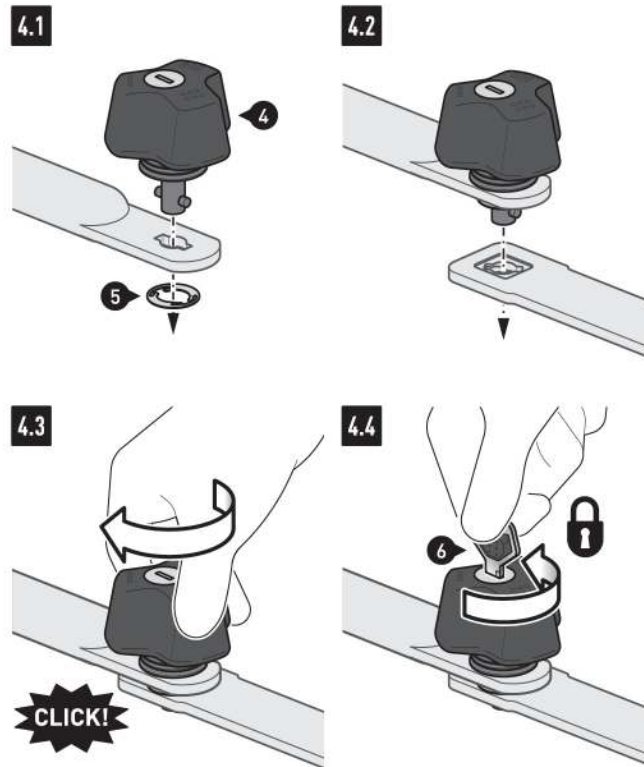

**Mount anti-theft protection device for PRO side carrier**

**4.1** - Insert the anti-theft protection device (5) into the side carrier opening defined in the side carrier mounting instructions. Secure the anti-theft protection device (5) with the lock washer (6).

**4.2** - Now insert the anti-theft protection device (5) in the opening of the side support fastener ...

**4.3** - ... and turn the anti-theft protection device (5) until it engages.

**4.4** - Then the anti-theft protection device (5) must be secured against unscrewing.

**⚠ NOTE:** NEVER lubricate the lock cylinder with oil! Only use graphite powder!



**PRODUCT-SPECIFIC NOTES**

**⚠ NOTE:** *Observe the country-specific regulations for the registration/operation of your vehicle or applicable TÜV regulations. After assembly, have parts that are subject to registration entered in the vehicle documents by your test centre.*